

ZFP

Networkable Analogue Addressable Fire Alarm Control Panel

Standard 1 to 4 Loop Panel
Medium 1 to 8 Loop Panel
Large 1 to 8 Loop Panel



Compact Controllers

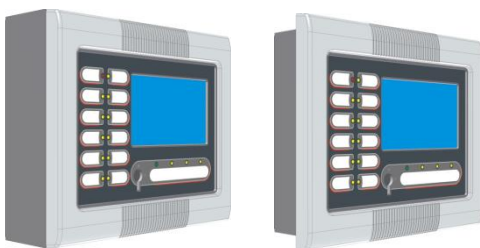

Installation, Maintenance & Programming Manual

Approved Document No. DFU5000503 Rev 6

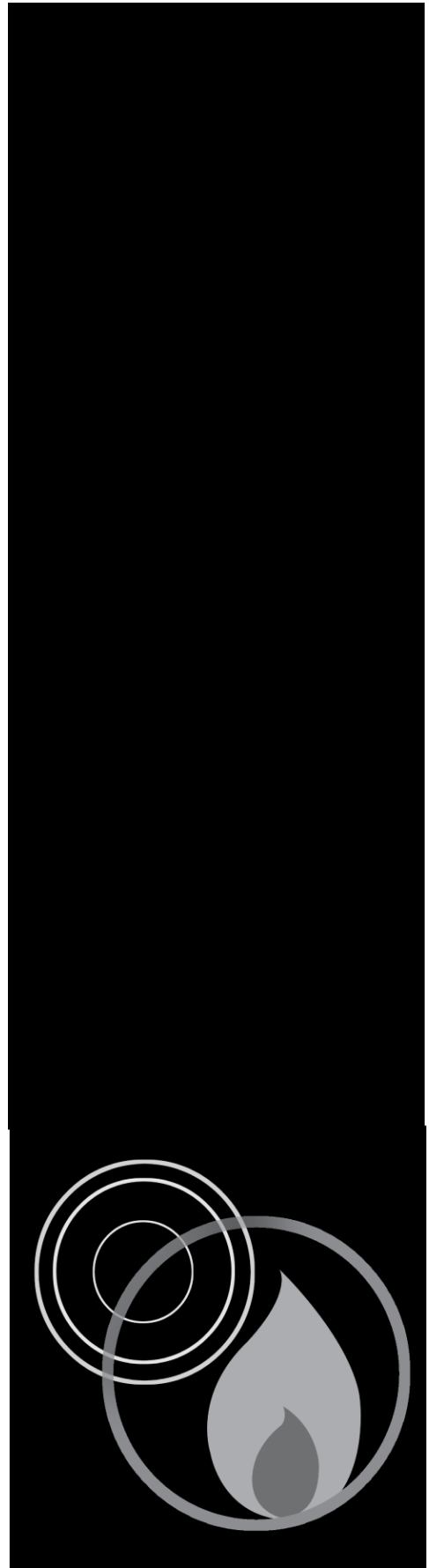



CAUTION !

DO NOT connect or disconnect the panel's internal wiring / looms, or terminate field wiring at the PCBs, with the panel's power applied (either Mains or battery). Failure to observe this will destroy the panel's electronic components and the warranty will be void.

Contents

NOTE: A GLOSSARY OF TERMS USED IN THESE INSTRUCTIONS IS LISTED IN APPENDIX 7.

1	IMPORTANT NOTES	5
1.1	STANDARDS	5
1.2	ITEMS SUPPLIED	5
1.3	NOTICES	5
1.4	SYSTEM DESIGN	6
1.5	EQUIPMENT GUARANTEE	6
2	ZFP KEY FEATURES	6
	EN54 COMPLIANCE STATEMENT	6
2.1	OPTIONAL NETWORKING (NON-EN54-2 APPROVED)	7
3	SYSTEM DESIGN	8
3.1	TYPICAL 4 LOOP ZFP PANEL BLOCK DIAGRAM	8
4	CABLING REQUIREMENTS	9
4.1	MAINS WIRING	9
4.2	FIELD WIRING	9
4.3	TESTING OF FIELD WIRING	9
5	INSTALLATION	10
5.1	ENCLOSURE DESCRIPTION	10
5.2	MOUNTING LOCATION	11
5.3	REMOVING THE LID, PCB CHASSIS AND PSU	11
5.4	PLANNING THE CABLE LAYOUT IN THE PANEL AND REMOVING KNOCKOUTS	11
5.5	WALL MOUNTING THE BACK BOX	11
5.6	REINSTALLING THE PSU, PCB CHASSIS AND LID	12
5.7	INSERTING THE 'SLIDE-IN' LABELS	12
5.8	FITTING THE 2-LOOP PCB (OPTIONAL)	12
5.9	COMPACT CONTROLLERS (OPTIONAL)	13
5.10	ANALOGUE ADDRESSABLE LOOP OVERVIEW	14
5.11	ANALOGUE ADDRESSABLE LOOP(S) WIRING	15
5.12	CONVENTIONAL SOUNDER CIRCUIT(S) WIRING	16
5.13	AUXILIARY INPUT WIRING	16
5.14	24V AUXILIARY POWER OUTPUT	17
5.15	RELAY OUTPUT WIRING	17

ZFP Networkable Analogue Addressable Fire Alarm Panel

5.16	REMOTE PC CONNECTION	17
5.17	PRINTER CONNECTION	17
5.18	CONNECTING MAINS TO THE PANEL'S PSU	18
5.19	CONNECTING THE STANDBY BATTERIES	19
6	'HI-NET' MULTIPATH NETWORKING (OPTIONAL)	20
6.1	SUMMARY OF NETWORK FEATURES	20
6.2	FITTING THE NETWORK PCB	20
6.3	'HI-NET' MULTIPATH NETWORK WIRING	21
6.4	'HI-NET' DIP SWITCH ADDRESS SETTINGS	22
6.5	FIBRE NETWORK WIRING FOR 'HI-NET'	23
6.6	ASSIGNING ID ADDRESSES AT ACCESS LEVEL 3	24
7	A-BUS (OPTIONAL)	25
7.1	Z11/Z12 RELAY PCB AND Z13/Z14 DIGITAL I/O PCB FEATURES	25
7.2	A-BUS DIP SWITCH ADDRESS SETTINGS	26
7.3	Z15 SOUNDER PCB FEATURES	27
7.4	Z16 ZONE SOUNDER PCB FEATURES	28
7.5	FITTING A-BUS PCBs	29
7.6	A-BUS WIRING	30
7.7	Z15 AND Z16 CONVENTIONAL SOUNDER CIRCUIT(S) WIRING	32
7.8	Z16 CONVENTIONAL ZONE CIRCUIT(S) WIRING	32
8	TOUCHSCREEN, INDICATORS & CONTROLS	33
9	COMMISSIONING & PROGRAMMING	33
	EN54 COMPLIANCE STATEMENT	33
9.1	RECOMMENDED SHORTFORM INSTALLATION & COMMISSIONING PROCEDURE	34
9.2	ACCESS LEVEL 3 MENU STRUCTURE	36
9.3	HOW TO ENTER ACCESS LEVEL 3 (AL3)	36
9.4	ENGINEERING FUNCTIONS	37
9.4.1	Device Manager	37
9.4.2	Contamination Check	39
9.4.3	Show PSU Status	40
9.4.4	Test Input Group	40
9.4.5	Test Output Group	40
9.4.6	Walk Test	40
9.4.7	Clear All Tests	40
9.4.8	Show Loop Status	40
9.4.9	Change Access Level 2 (AL2) Code	41
9.4.10	Change Access Level 3 (AL3) Code	41
9.4.11	Panel Notes	41
9.4.12	Show System Details	42
9.4.13	Safe Mode	42
9.4.14	Clean Start	42
9.4.15	Backup System Devices	42
9.4.16	Restore System Devices	42
9.4.17	Backup/Restore Config	42
9.4.18	Diagnostics	42
9.4.19	Firmware Update	42
9.4.20	PM Firmware Update	42
9.5	COMMISSIONING FUNCTIONS	43
9.5.1	Loop Learn	43
9.5.2	Device Manager	44
9.5.3	Find New Devices	44
9.5.4	Add/Delete/Edit a Device	44
9.5.5	Edit Zone Name	44

ZFP Networkable Analogue Addressable Fire Alarm Panel

9.5.6	Edit Input Group Name	45
9.5.7	Edit Output Group Name.....	45
9.5.8	Setup Panel Printer.....	45
9.5.9	Setup Networking	45
9.5.10	Select Language	45
9.5.11	Synchronise Network Data.....	45
9.5.12	LCD Auto-Dimming.....	46
9.5.13	Set Loops Fitted.....	46
9.5.14	Zone Configuration.....	46
9.6	EVENT LOG FUNCTIONS	47
9.7	DISABLEMENT FUNCTIONS.....	48
9.7.1	Supervisory Disablements.....	48
9.7.2	Enable/Disable Zones.....	49
9.7.3	Enable/Disable Devices.....	49
9.7.4	Enable/Disable Sounders	49
9.7.5	Enable/Disable Input Groups.....	49
9.7.6	Enable/Disable Output Groups	50
9.7.7	Enable/Disable Panel Printer.....	50
9.7.8	Clear All Disablements	50
9.8	SET THE PANEL'S TIME AND DATE.....	51
9.9	SHOW SUPERVISORY EVENTS	51
10	MAINTENANCE	52
	APPENDIX 1 – ENCLOSURE DIMENSIONS AND FIXING DETAILS.....	53
	APPENDIX 2 – BEZELS (FLUSH-MOUNT).....	55
	APPENDIX 3 – CHASSIS.....	56
	APPENDIX 4 – LIST OF MODULES	57
	APPENDIX 5 – STANDBY BATTERY CALCULATION GUIDE.....	58
	APPENDIX 6 – ZFP TECHNICAL SPECIFICATION	59
	APPENDIX 7 – GLOSSARY OF TERMS	61

Figures

Figure 1	– Typical 4 Loop ZFP Panel Block Diagram	8
Figure 2	– Location of Standard 1 to 4 Loop Version Components	10
Figure 3	– Typical Analogue Addressable Loop Overview	14
Figure 4	– Analogue Addressable Loop Connections	15
Figure 5	– Conventional Sounder Circuit Connections	16
Figure 6	– Auxiliary Input Connections	16
Figure 7	– 24V Auxiliary Output Connections.....	17
Figure 8	– Relay Output Detail.....	17
Figure 9	– PC Connection.....	17
Figure 10	– 5A PSU Layout and Mains Connection Details (with protective cover removed).....	18
Figure 11	– Battery Connection Details	19
Figure 12	– Fitting the 'Hi-NET' Network PCB	20
Figure 13	– 'Hi-NET' Multipath Network Wiring	21
Figure 14	– Z11/Z12 Relay PCB and Z13/Z14 Digital I/O PCB Wiring	30
Figure 15	– Z15 Sounder PCB Wiring	30
Figure 16	– Z16 Zone Sounder PCB Wiring	31
Figure 17	– Z16 Conventional Sounder Circuit Connections.....	32
Figure 18	– Z16 Conventional Zone Circuit Connections	32
Figure 19	– Access Level 3 Menu Structure.....	35

1 IMPORTANT NOTES

1.1 Standards

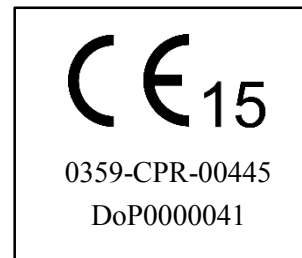
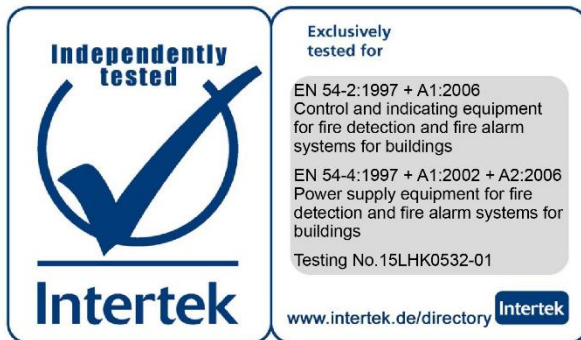

1.2 Items Supplied

- ZFP Fire Alarm Control Panel, as ordered.
- Installation, Maintenance & Programming manual (this manual) – Explains how to install, commission and maintain the fire alarm control panel. **This manual must not be left accessible to the user.**
- User Manual and Log Book (Document No. DFU5000501) – Gives detailed operational information and details about the panel's touchscreen, indicators and controls.
- Quick start guides for users (Document No. DFU5000502) and engineers (Document No. DFU5000504) – Summarize key information provided in the main manuals.
- Key for unfastening / securing the panel lid.
- Electrical accessory pack, containing:
 - 1 x 20mm 2ATH 250V HRC ceramic fuse (spare primary fuse)
 - 1 x 20mm 5A F ceramic fuse (spare battery fuse)
 - 1 x set of battery link wires and nylon cable ties
 - 4 x 6K8 0.25W EOL resistors for conventional sounder circuits (2) and auxiliary inputs (2)
 - 2 x 470R 0.25W trigger resistors for auxiliary input circuits.

1.3 Notices



WARNINGS!

This equipment must only be installed and maintained by a suitably skilled and technically competent person.

This equipment is a piece of Class 1 equipment and MUST BE EARTHED.

ALWAYS isolate the panel's Mains and battery backup supplies before making connections to its PCBs.



Anti-static handling guidelines

Make sure that handling precautions for electro-static devices (ESD) are taken immediately before handling PCBs and other ESD components. Before handling any ESD items, engineers should get rid of any electro-static charge by touching a sound safety earth. Always handle PCBs by their sides and avoid touching any electronic components. PCBs should be stored in a clean, dry place that is free from vibration, dust and excessive heat.

Disclaimer

Errors and omissions excepted (E&OE). No responsibility can be accepted by the manufacturer or distributors of this range of fire panels for any misinterpretation of an instruction or guidance note or for the compliance of the system as a whole. The manufacturer's policy is one of continuous improvement and we reserve the right to make changes to product specifications at our discretion and without prior notice.

1.4 System Design

Fire alarm system design is beyond the scope of this document. A basic understanding of general fire alarm system components and their use is assumed.

Contact the Fire Officer concerned with the property at an early stage in case he has any special requirements. We strongly recommend that a suitably qualified and competent person is consulted in connection with the design of the fire alarm system.

The equipment must be installed, operated and maintained in accordance with these instructions and the appropriate national, regional or local regulations. If in doubt please consult your distributor.

We recommend you read BS 5839-1, Fire detection and alarm systems for buildings: Code of practice for system design, installation and maintenance, available at your local reference library or from the BSI. Other national standards of installation should be referenced where applicable.

1.5 Equipment Guarantee

This equipment is not guaranteed unless the complete installation is installed and commissioned in accordance with the laid down national, regional or local standards (in the UK BS 5839 Part 1) by an approved and competent person or organisation.

2 ZFP KEY FEATURES





EN54 Compliance Statement

The 'out-of-the-box' fire alarm panel is fully compliant with the requirements of EN54-2 (Fire detection and fire alarm systems, control and indicating equipment) and EN54-4 (Fire detection and fire alarm systems, power supply equipment) and is 3rd party certified as meeting these standards.



Please note, some of the Key Features listed below, go beyond the scope of EN54-2. A caution symbol (shown left) is used to indicate where such a feature is non-EN54-2 approved. DO NOT affix the EN54 approval label (supplied) to the front of the panel if it has been configured to operate in a way that would make it non-compliant with the requirements of EN54-2.

Dependant on the model purchased, the ZFP range of fire alarm control panels include the following features:

- Designed to comply with EN 54 Parts 2 and 4
- Compatible with Apollo's XP95 / Discovery communication protocols
- Three cabinet sizes are available:
 - Standard – 1 chassis c/w 2 modules (1, 2 or 4 addressable loops)
 - Medium – 2 chassis c/w 4 modules (1, 2, 4, 6 or 8 addressable loops). **Non-EN54-2 approved.** 
 - Large – 3 chassis c/w 6 modules (1, 2, 4, 6 or 8 addressable loops). **Non-EN54-2 approved.**
- 'Compact' controller option (surface or flush mount versions). **Non-EN54-2 approved.**
- Modular construction
- Integrated printer option with front loading paper. **Non-EN54-2 approved.** 
- 5A EN 54-4/A2 PSU and battery charger included in all panels
- Up to 18Ah batteries in a standard cabinet, up to 38Ah in the medium and larger cabinets
- 4.3 inch, 480 x 272 pixel, 24 Bit, 16M colour LCD touchscreen
- Separate distinct LEDs for mandatory EN 54 indications plus programmable LEDs
- One RS232 port - for ancillary devices, e.g. pagers / DECT telephone systems / Graphics Interface
- Two RS485 ports – one for A-Bus (connects peripheral PCBs), one for Graphics Interface / Diagnostics
- Fault tolerant network – needs a separate 'Hi-NET' multipath network PCB. **Non-EN54-2 approved.** 
- Up to 64, eight loop, peer-to-peer panel network capacity (max. network length = 128km, maximum distance between each network 'node' = 1km). **Non-EN54-2 approved.** 

ZFP Networkable Analogue Addressable Fire Alarm Panel

- Integrated ‘galvanically - isolated’ USB connection to a PC running programming tools
- Two independently programmable 1A conventional sounder circuits – monitored.
- Up to 10,000 programmable and indicatable system zones (maximum 200 zones per panel)
- 20,000+ event memory for all fire, fault and system events - all filterable
- Greater than 50,000 addressable device system capacity
- Three access levels – access level 1 (general user), access level 2 (authorised user) and access level 3 (authorised systems engineer) with keyswitch entry to access level 2
- A day/night function (building occupied/unoccupied) including detector sensitivity (high/low) and zone dependency settings. **Non-EN54-2 approved.** 
- An investigation delay period function (programmable for length of time, which zone(s) it applies to and whether or not it operates in day/night mode) which works as follows:

When there is an alarm programmed to operate in ‘investigate’ mode, the full alarm condition will occur after a delay. It is possible to manually impose a further delay, to allow the source of the alarm to be investigated. If the second delay expires, or there is another alarm in the same zone, then a full alarm condition is established. During either delay period, the panel may be reset in the case of a false alarm.
- Individual sensitivity settings for each device
- Selectable language
- Real-time clock with automatic daylight saving time
- Standard upload download software includes facility to upload company logos – even from a simple .gif file from a camera
- Up to 16 GB (2 GB as standard) internal micro SD memory card.

In addition to the mandatory requirements of EN 54-2, the panel meets the following criteria:

- The panel has a Zone Configuration function (see section 9.5.14). This function should not be ticked otherwise it will make the panel non-compliant with the requirements of EN54-2.
- EN 54-2 Clause 7.8 ‘Output to fire alarm devices (option with requirements)’ to enable an audible warning to be sounded throughout the premises upon the detection of a fire condition or the operation of a manual call point.
- EN 54-2 Clause 7.11 ‘Delays to outputs (option with requirements)’ of fire alarm devices (sounders) so that an alarm may be verified before a premises is evacuated.
- A selection of zone dependency functions (EN 54-2 Clause 7.12, type A or B) as detailed below:

Clause 7.12.1 ‘Type A dependency (option with requirement)’ - If there is an alarm from a detector, the panel will look for a confirmatory alarm from the same or another detector in the same zone before a full alarm is established. If there is no confirmatory alarm, the first alarm will automatically reset.

Clause 7.12.2 ‘Type B dependency (option with requirement)’ - As type A except the confirmatory alarm from another detector in the same zone or a different zone.

Important Note: Type A & B dependencies should not be selected to operate together at the same panel as the initiation of an alarm in one zone will cause a type B dependency on another zone, even if a type A dependency has been set. Dependencies are selected using the panel’s ZTOOLS.
- EN 54-2 Clause 7.13 ‘Alarm counter (option with requirements)’ to record the number of instances the panel enters the fire alarm condition.
- EN 54-2 Clause 8.3 ‘Fault signals from points (option with requirements)’.
- EN 54-2 Clause 9.5 ‘Disablement of addressable points (option with requirements)’.
- EN 54-2 Clause 10 ‘Test condition (option with requirements)’ to allow the automatic resetting of zones in alarm for testing purposes.

2.1 Optional Networking (non-EN54-2 approved)



If required, a panel or compact controller can be configured to sit on a ZFP ‘Hi-NET’ multipath network. To communicate over a network, each network node (panel or compact controller) requires an RS485 network interface PCB. See section 6 for details.

3 SYSTEM DESIGN

3.1 Typical 4 Loop ZFP Panel Block Diagram

Note that only one analogue loop is available on the 1 loop panel version.

Figure 1 – Typical 4 Loop ZFP Panel Block Diagram

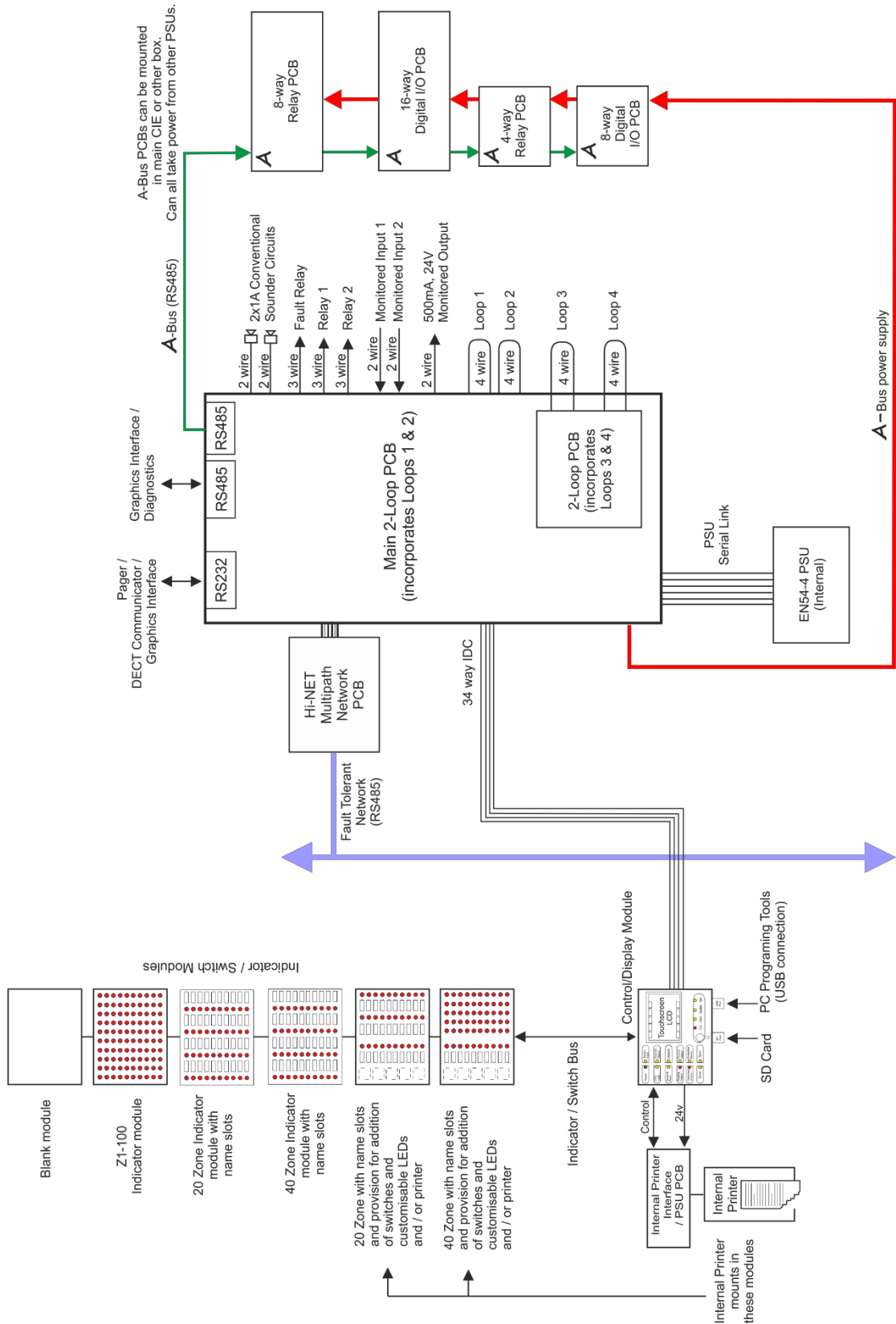

4 CABLING REQUIREMENTS



All installation wiring must be checked and tested before termination at the panel. Always isolate the panel's Mains and battery backup supplies before cable termination at the panel.

4.1 Mains Wiring

Mains wiring must be installed in accordance with all applicable national, regional or local standards. In the UK this is BS 7671 IEE Wiring Regulations and BS 5839-1, Fire detection and alarm systems for buildings: Code of practice for system design, installation and maintenance.

Mains wiring should be fire resistant and segregated from extra low voltage field wiring.

The general requirement for the 230V, 50Hz Mains supply to the ZFP panel is fixed wiring, using 3 core cable (no less than 1mm² and no more than 2.5mm²), or a suitable three conductor system fed from an isolating switched fused spur, fused at 3A. The Mains supply must be exclusive to the panel, secure from unauthorised operation, and be marked 'FIRE ALARM: DO NOT SWITCH OFF'.



Hint: As an alternative to a switched fused spur, a double pole isolating device (B) may be used in the Mains feed from the Main Distribution Board (A) to the ZFP Panel (C), providing it meets the appropriate wiring regulations - see diagram below.

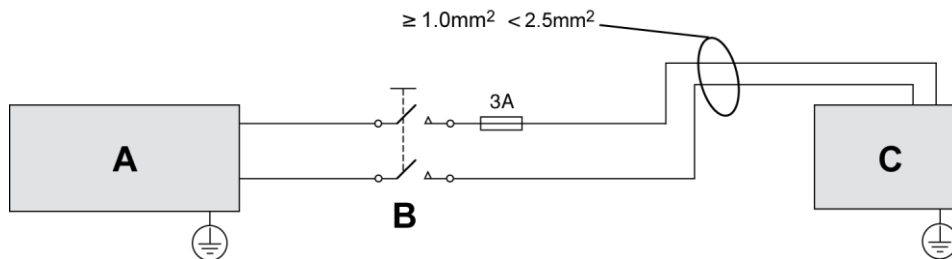

4.2 Field Wiring

Separated or Safety Extra-Low Voltage (SELV) field wiring includes loop circuits, sounder circuits and auxiliary inputs/outputs. SELV field wiring must be installed in accordance with the relevant national, regional or local regulations (in the UK this is the IEE Wiring Regulations BS 7671 and BS 5839 Part 1).

Fire resistant, screened cable should be used throughout the installation. This not only shields the data moving up and down the cables from outside interference but is essential to ensure compliance with EMC regulations. All screens must only be terminated to the earth bar provided in the panel's back box.

Screened cables such as FP 200™, Firetuff™, Firecel™ and MICC may be acceptable provided they meet national standards / the system specification as applicable. Consult Clause 26 of BS 5839 Part 1 for more detailed information on cables, wiring and other interconnections.

4.3 Testing of Field Wiring

Check the continuity of the loops (including screens), loop earth faults, loop crossover faults, the resistance of the conventional sounder circuits and all other field wiring as appropriate to ensure they are free from faults.



DO NOT test wiring with an insulation tester (Megger) with any electronic equipment connected as the 500V test will destroy these devices and invalidate the warranty.

5 INSTALLATION



Note: See section 9.1 for a recommended shortform installation procedure.

5.1 Enclosure Description

The panel's enclosure comprises of a hinged steel lid and a steel back box which houses a power supply unit (PSU) and several printed circuit boards (PCBs) mounted on a metal chassis, as shown in figure 2 below. Space is available inside the back box for the backup batteries.

The panel can be surface or semi-flush wall mounted (a bezel is required for semi-flush mounting). The standard ZBOXS, 1 to 4 loop version enclosure, is shown below.

Figure 2 – Location of Standard 1 to 4 Loop Version Components

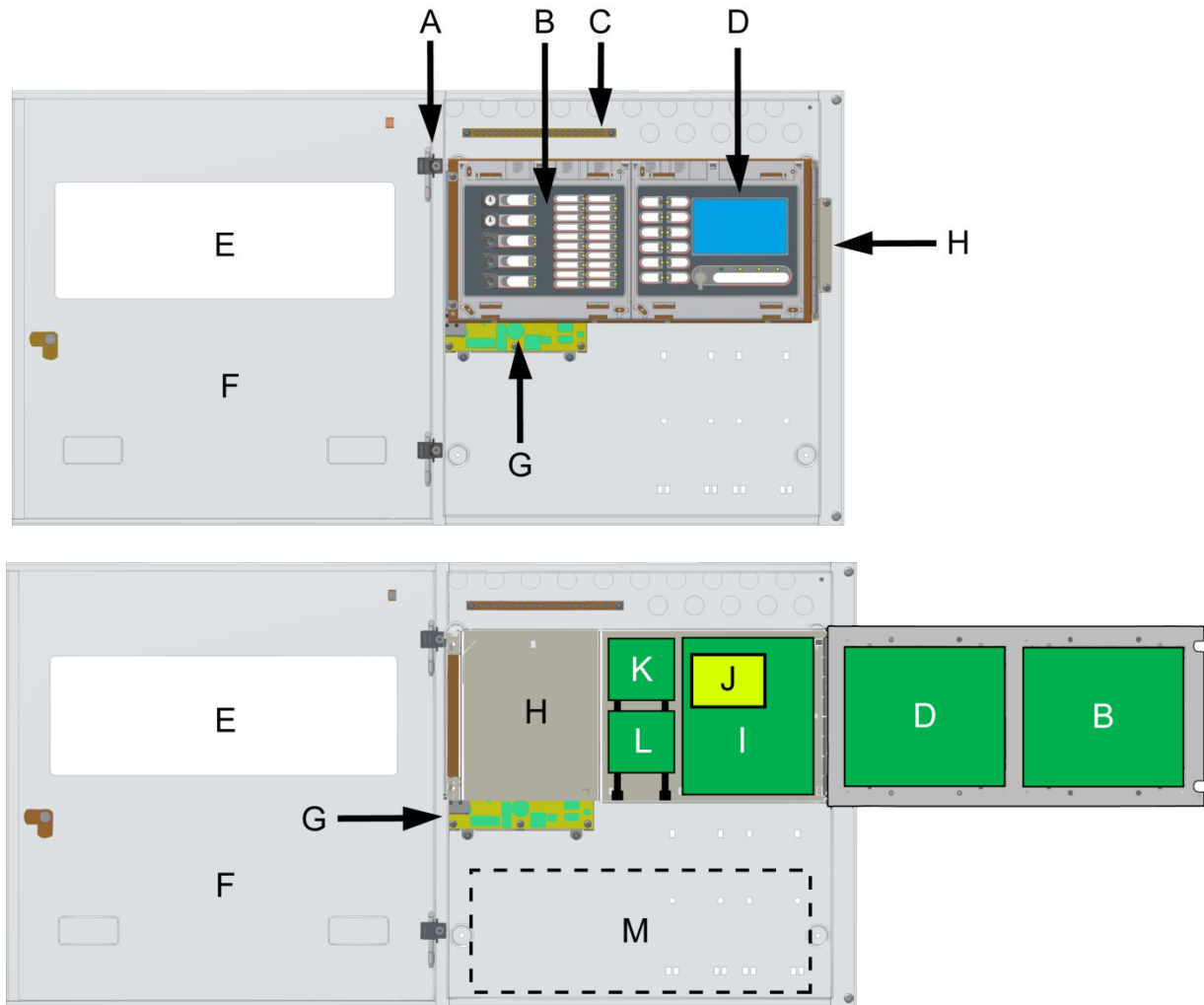

Figure 2 key:

A	Lid Hinge Pins – 2 off	H	PCB Stepped Chassis
B	Module (20 zone, 5 switches, 10 LEDs - Z45 Module shown)	I	Main 1 or 2-Loop PCB (dependent on model)
C	20-way heavy duty brass earth bar. DO NOT operate equipment without connecting cable screens to this bar.	J	2-Loop PCB adds two additional loops. (Part No. Z02LOOP/X). Optional. NOT AVAILABLE FOR A 1 LOOP PANEL.
D	Control/Display Module (Part No. Z41) incorporates the touchscreen	K	'Hi-NET' Network Multipath PCB (Part No. ZHN). Optional.
E	Lid Aperture	L	A-Bus PCB. Optional.
F	Lid.	M	Space for up to 2 x 12 V, 18 Ah batteries
G	PSU		

5.2 Mounting Location

Each panel must wall mounted, indoors and MUST NOT be subjected to conditions that are likely to affect their performance, e.g. damp, extreme temperatures, physical abuse, etc.

They should be sited at an easily accessible height and in a prominent position within the building. The ambient light and sound levels should allow the indicators and touchscreen to be clearly visible and the internal buzzer clearly heard. Typical locations for the panel are in the entrance foyer / hallway at ground floor level (the first and most obvious point of contact for emergency services) or in a permanently manned security office.

5.3 Removing the Lid, PCB Chassis and PSU

To protect the panel's electronic components from damage and also to expose the back box mounting holes, the panel's lid, PCB chassis and PSU should be removed prior to initial installation. When removed, all panel components should be stored in a clean, dry place which is free from vibration, dust and excessive heat.



Hint: Retaining the components in a suitable cardboard box will also guard them against mechanical damage.

To remove the lid:

- Use the supplied key to unlock the lid.
- Open the lid 180° to the left (do not overbend the hinges), then disconnect the lid's earth strap.
- By hand, or by using a screwdriver, push out the lid's two plastic hinge pins (shown right) and lift off the lid.

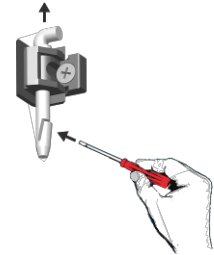

To remove the PCB chassis and PSU:



See 'Anti-static handling guidelines' in section 1.3

- Disconnect the earth strap from the PCB chassis. Remove the four retaining screws that secure the PCB chassis in the back box and carefully remove the chassis to expose the PSU.
- Pull the PSU's earth strap off the spade connector at the back box's earth point. Remove the four retaining nuts and washers that secure the PSU in the back box and carefully remove the PSU.

5.4 Planning the Cable Layout in the Panel and Removing Knockouts

Mains wiring should be segregated from extra low voltage field wiring. Leave sufficient tails inside the panel to ensure straightforward connection of wiring to the panel's terminals.

All cables should be fed into the panel through the knockouts provided in the back box.

Knockouts should be removed with a sharp, light tap using a 6mm flat-bladed screwdriver as shown in the diagram (right). Ensure any swarf is removed from the enclosure.

Always ensure if a knockout is removed, the hole is filled with a good quality 20mm cable gland. Any unused knockouts must be securely blanked off.

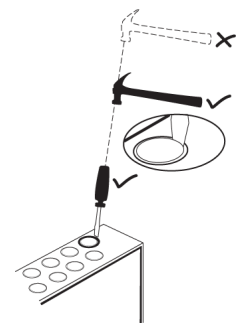

5.5 Wall Mounting the Back Box

Note: The panel can be surface or semi-flush mounted on a wall (note optional bezels are available for semi-flush mounting).



CAUTION: The enclosures are heavy! Therefore, use suitable screw fixings for wall mounting the enclosures.

Securely fix the panel to a wall using the four (Ø4.7mm) mounting holes provided in the back box. The mounting holes are suitable for use with No.8 roundhead or countersunk screws

See Appendix 1 for enclosure fixing details.

Always assess the condition and construction of the wall and use suitable screw fixings. Any dust or swarf created during the fixing process must be removed from the inside of the back box.

Ensure there is sufficient space to allow the lid to be fitted / removed when the panel is wall mounted.

5.6 Reinstalling the PSU, PCB Chassis and Lid

Refit the panel's PSU, PCB chassis and lid by following the removal procedure (section 5.3) in reverse order.

Note that the panel's PSU will have to be refitted and connections made to it before the chassis is refitted. See Connecting Mains – section 5.18 and Connecting the Standby Batteries – section 5.19.

5.7 Inserting the 'slide-in' labels

A 'slide in' label system is employed by the ZFP for customizing language labels and description of zones / programmable LEDs.

Insert the slide-in labels (supplied in the accessory pack) for the ancillary modules), as shown right.

Note: The label inserted for the module's control buttons depends on how the unit has been configured.

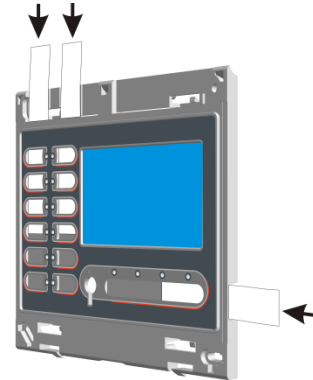

5.8 Fitting the 2-Loop PCB (Optional)

An optional 2-Loop PCB (Part No. Z02LOOP/X) provides two additional analogue loop connections (Loop3 & Loop4) if required. Note this PCB is not available for the 1 loop panel version.

With reference to the diagram below:

- Take the 2-Loop PCB and carefully align its holes up with the four mounting holes on the Main 2-Loop PCB.
- Insert the four PCB 'plug-on' pillars (supplied with the 2-Loop PCB) through the holes on the 2-Loop PCB and into the holes on the Main 2-Loop PCB. Push the pillars until they click and lock in position.
- Refer to section 5.11, figure 4 for analogue loop connections.

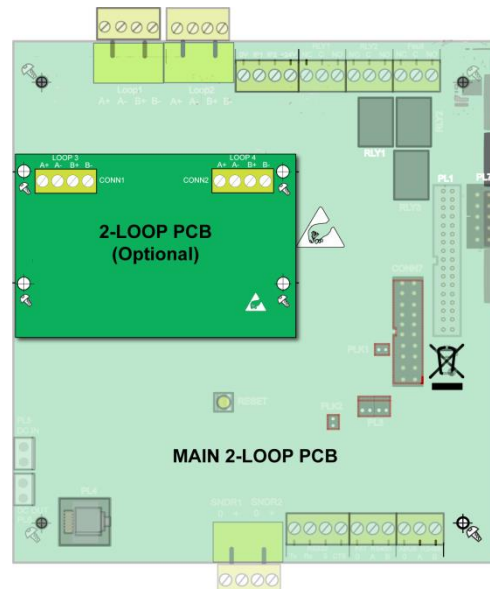

5.9 Compact Controllers (Optional)

The compact controller is an optional network node that can be used to operate the system. It is a loopless device, with a lesser amount of functionality compared to a ZFP panel. Both flush and surface mounted versions are available:

- ZFP Compact Controller (flush) c/w Hi-NET network PCB - Part No. ZREP1F.
- ZFP Compact Controller (surface) c/w Hi-NET network PCB - Part No. ZREP1S.

Summary of Compact Controller Features

- For controller dimensions and fixing details – see Appendix 1.
- Menu, Silence, Reset and Mute buttons are available at the controller’s touchscreen.
- Alarms, Faults, Disablements and Tests buttons are available at the controller’s touchscreen.
- A controller comes with a network PCB fitted as standard, enabling it to communicate with other nodes (panels or controllers) over a ZFP network. See networking section 6 for details.
- Each controller requires an EN 54-4/A2 boxed PSU (not supplied). See networking section 6.3, figure 13 for the controller’s PSU connection details.



Hint: The BF360-24 (24V 1.5A) PSU may be used to power a controller.

C-TEC supply a range of power supplies, third-party certified to EN 54-4/A2. Contact your distributor for details.

- A controller has a limited number of touchscreen menus available compared to a panel. These are listed below. Refer to section 9 for menu details.

Access Level 1 menus	Access Level 2 menus	Access Level 3 menus	Access Level 3 Engineering sub-menus
Access Level 2	Access Level 3	Engineering Functions	Device Manager
Access Level 3	ReSound Sounders	Event Log Functions	Test Output Group
Lamps Test	Alarm Counter	Disablement Functions	LCD Auto-Dimming
View Alarm Counter	Disablement Functions	Setup Networking	Change AL2 Code
Clean the Display	Set Time/Date	Set Time/Date	Change AL3 Code
		Show Supervisory	Panel Notes
			Show System Details
			Select Language
			Safe Mode
			Clean Start
			Backup System Devices
			Restore System Devices
			Backup/Restore Config
			Diagnostics
			Firmware Update

Removing the Compact Controller’s Bezel

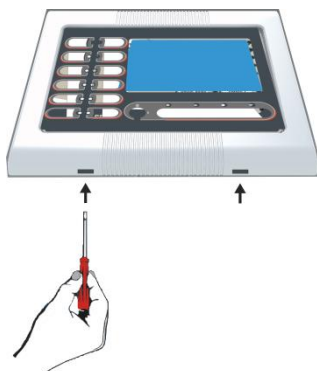

The compact controller’s front bezel must be removed to access the unit’s internal components and expose the back box mounting holes.

Using a small flat bladed screwdriver, push in the two tabs to release the bezel, as shown left.

5.10 Analogue Addressable Loop Overview

Figure 3 below shows a typical analogue addressable loop complete with detectors, manual call points, loop-powered sounders and ancillary devices. The descriptions and availability of the devices shown below may not be applicable to all manufacturers’ protocols – check with your distributor for further details. Also, this example arrangement of devices may not be permitted by design and installation regulations in certain countries.

The loop should be connected to the relevant connector block on the panel’s Main 1 or 2-Loop PCB (dependent on model) and its screens terminated at the panel’s earth bar as shown in section 5.11, figure 4.

Note that ‘Loop 2’, shown in Figure 3, is not applicable for the 1 loop panel version.

Figure 3 – Typical Analogue Addressable Loop Overview

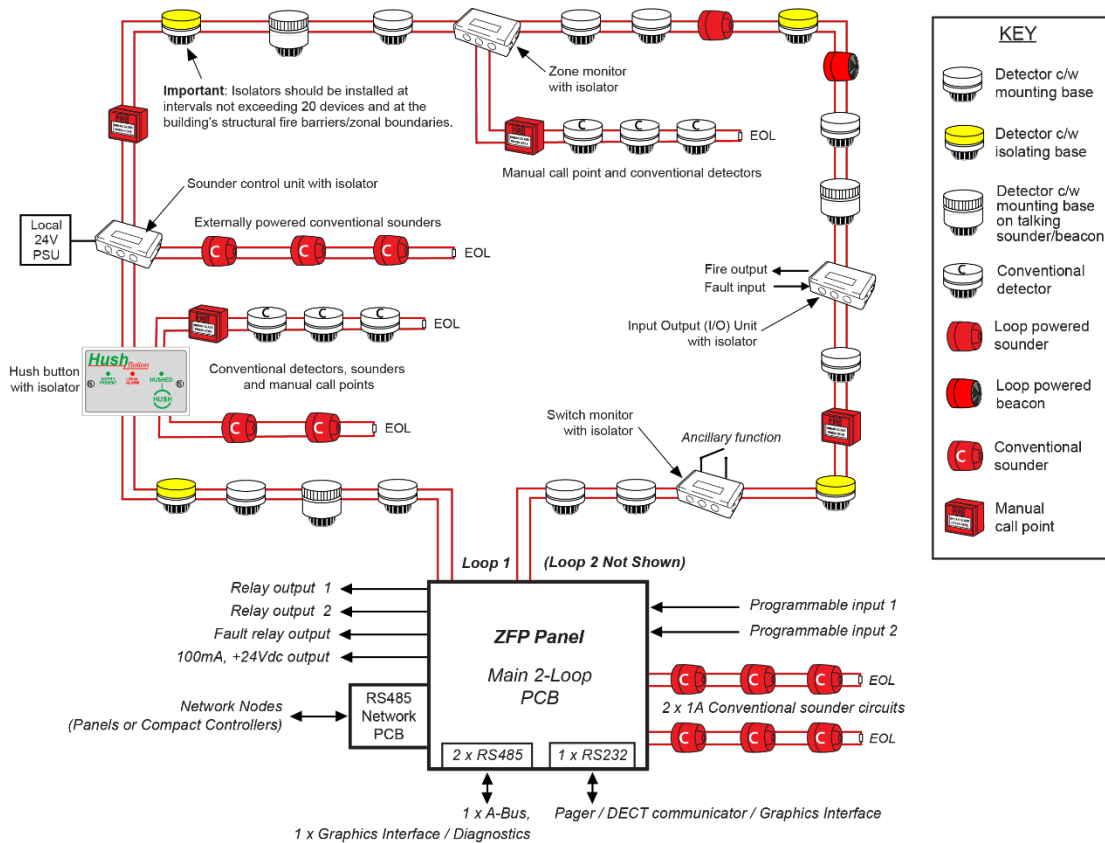

Design issues - reducing faults and their consequences

To ensure a reliable system, it should be designed and maintained to local design and installation regulations. Loop isolators should be included in the loop wiring. A single short circuit fault will now only disable devices in the section of wiring between isolators. Local design and installation regulations will dictate how many devices or zones may be lost in the case of this type of fault. In the case of a single open circuit no devices will be lost, since communication is from both ends of the loop, but a loop integrity fault will be shown. Note that a critical design issue with any analogue fire system is the combined effect of loop resistance, loop capacitance and the current demand of items connected to the loop. Factors that influence this include loop length, cable diameter, cable type, the number of isolators used and the number and type of devices between isolators. There are no hard and fast rules regarding these factors as every situation is unique. However, if the following conservative advice is followed, the loop WILL almost certainly work.

- **Absolute maximum loop length = 1km, with either 1mm² or 1.5mm² cables.**
- **No more than 20 addressable devices between loop isolators of which no more than 6 are loop sounders.**
- **If loop sounders are used, use 1.5mm² cable and do not fit more than 32 loop sounders per loop in total.**
- **If more than 10 loop sounders are used per loop then the maximum loop length per loop should be no greater than 750m.**

The above **SHOULD NOT** be considered the maximum operating conditions for the panel as many other permutations are possible. Any limitations are a consequence of device manufacturers’ protocol, coupled with the cable’s characteristics. The panel’s loop driver is easily capable of driving lightly loaded loops up to 4km long without a problem. However, devices connected at the end of 4km may not be able to read the data once corrupted by the cable.

ZFP Networkable Analogue Addressable Fire Alarm Panel

Important Note: Remember to isolate the panel's Mains and battery backup supplies before terminating wiring at the panel.

5.11 Analogue Addressable Loop(s) Wiring

Two analogue loop connections (Loop1 & Loop2) are available on a Main 2-Loop PCB, as shown in figure 4 below. One analogue loop connection (Loop1) is available on a Main 1-Loop PCB.

The maximum number of addressable devices per loop is 126 with a maximum of 512 detectors/call points per panel. The maximum output current per loop is 500mA. Plug-on 5mm connectors accept up to 2.5mm² cable.

An optional 2-Loop PCB (not available for the 1 loop panel version) provides two additional analogue loop connections (Loop3 & Loop4), if required (see section 5.8).

The loop's earth screens should be adequately insulated and ONLY terminated at the earth bar in the back box to ensure earth continuity. Check for loop earth faults and loop crossover faults.



The back box earth bar is provided for terminating earth screens or drains and is NOT the panel's main earth point. The installer must review the external earth bonding (if required) with respect to the national, regional or local wiring rules. If the installation requires protective earth bonding, then this must be applied externally and in conjunction with the type of earth system employed on site.

Figure 4 – Analogue Addressable Loop Connections

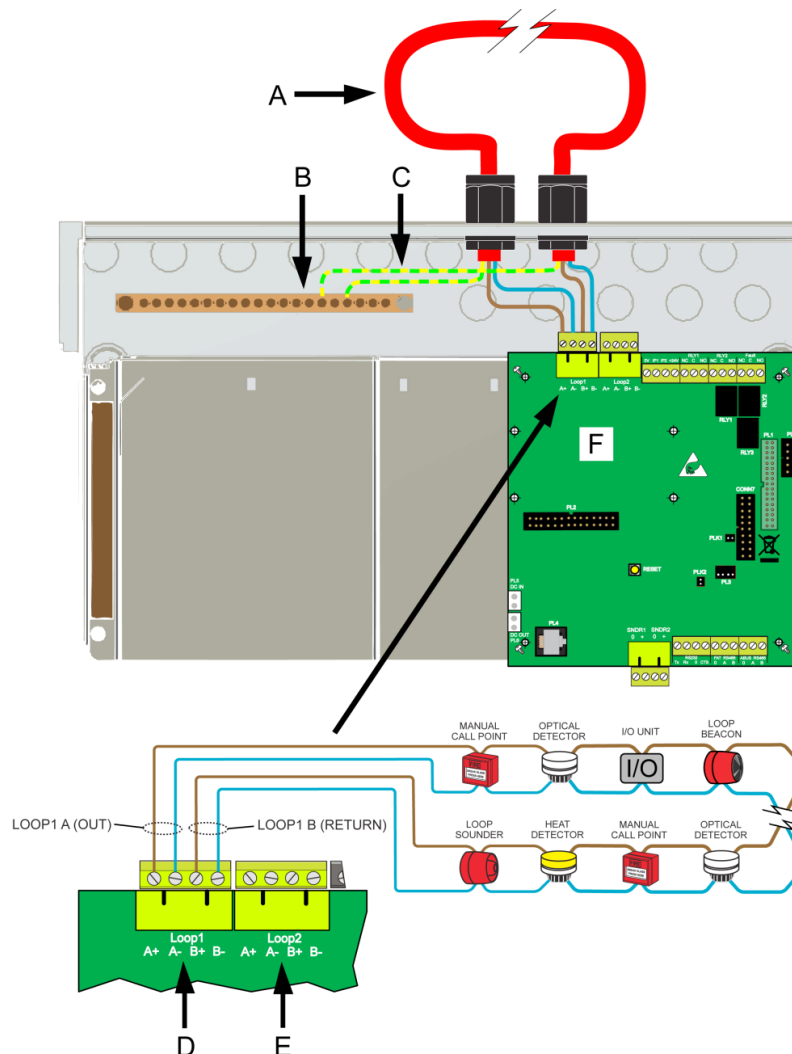

Figure 4 key:

A	Analogue Loop 1 Cable (fire resistant).	D	Analogue Loop 1 Connector (A+, A-, B+, B-). Plug-on connector type.
B	20-way heavy duty brass earth bar. DO NOT operate the equipment without connecting cable screens to this bar.	E	Additional Analogue Loop 2 Connector (A+, A-, B+, B-). Plug-on connector type. Wiring not shown. NOT APPLICABLE FOR A 1 LOOP PANEL.
C	Cable Earth Screens.	F	Main 2-Loop PCB.

5.12 Conventional Sounder Circuit(s) Wiring

Two conventional sounder circuits are provided on the Main 1 or 2-Loop PCB (dependent on model), each circuit has a maximum rating of 1A. If a full complement of sounders or bells are to be used, split them equally across both circuits.

Each sounder circuit should be connected to the terminals marked SNDR1 & SNDR2 as shown in figure 5 below and its earth screens terminated at the back box earth bar. Plug-on 5mm connectors are provided that accept up to 2.5mm² cable.

Note: ALWAYS make sure the two 6k8 EOL resistors (supplied) are fitted across the terminals of the last sounder on each circuit to allow the wiring to be monitored for open and short circuit faults. If a sounder circuit is unused, you must still connect the resistor at the panel terminals.

Figure 5 – Conventional Sounder Circuit Connections

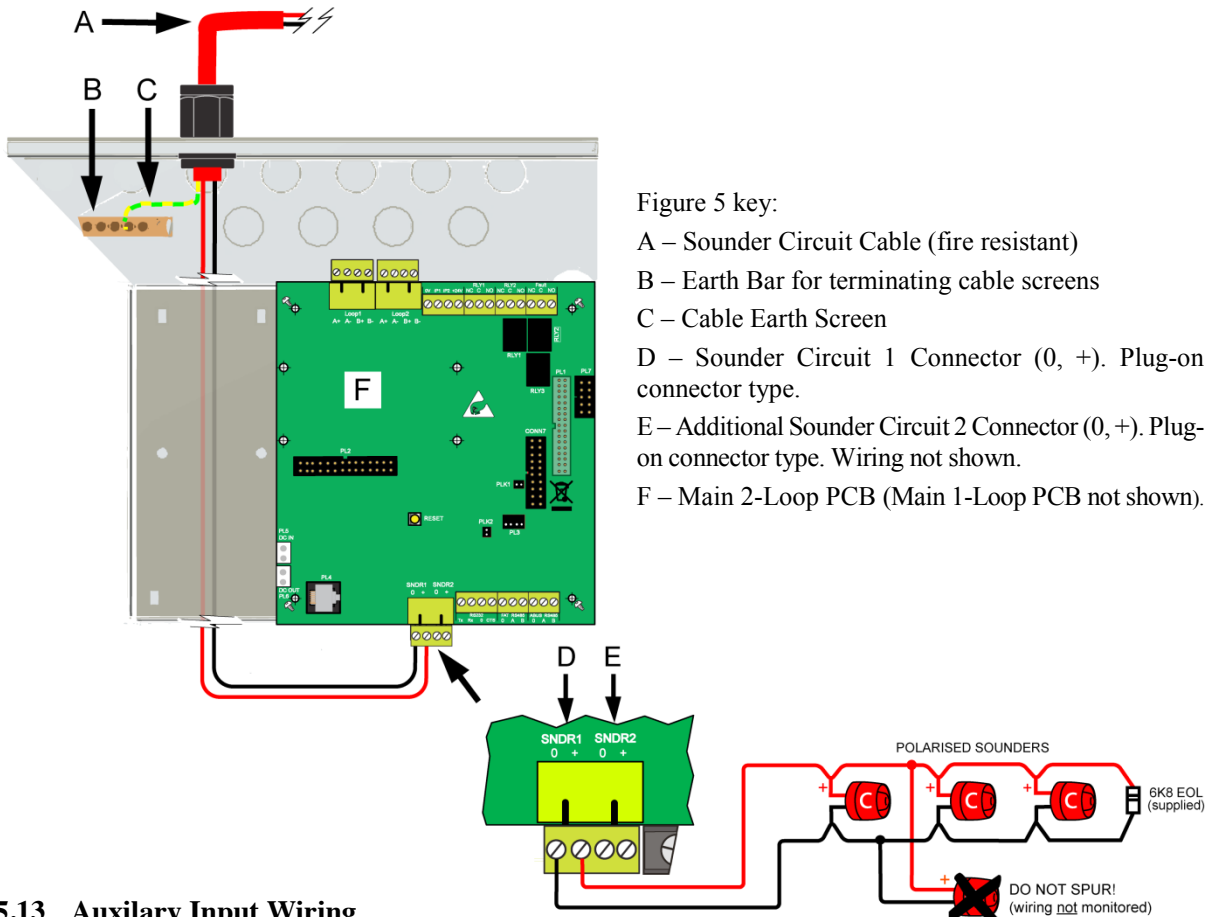

- Figure 5 key:
- A – Sounder Circuit Cable (fire resistant)
 - B – Earth Bar for terminating cable screens
 - C – Cable Earth Screen
 - D – Sounder Circuit 1 Connector (0, +). Plug-on connector type.
 - E – Additional Sounder Circuit 2 Connector (0, +). Plug-on connector type. Wiring not shown.
 - F – Main 2-Loop PCB (Main 1-Loop PCB not shown).

5.13 Auxiliary Input Wiring

Figure 6 – Auxiliary Input Connections

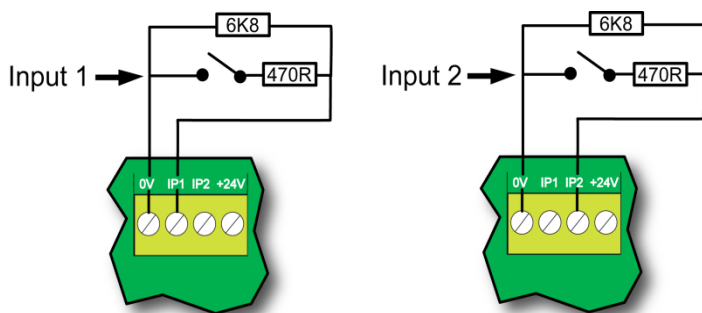

Two programmable auxiliary input connections are provided on the Main 1 or 2-Loop PCB (dependent on model).

The wiring for each input should be connected to the terminal block marked IP1 & IP2 with a 470R 0.25W trigger resistor (supplied) in each leg, as shown in figure 6, left.

If required, input wiring screens can be terminated at the earth bar in the same way as the analogue loop earth screens.

Note: ALWAYS make sure the two 6k8 EOL resistors (supplied) are fitted across the terminals of the last device on each input to allow the wiring to be monitored for open and short circuit faults. If an input is unused, you must still connect the resistor at the panel terminals.

5.14 24V Auxiliary Power Output

Figure 7 – 24V Auxiliary Output Connections

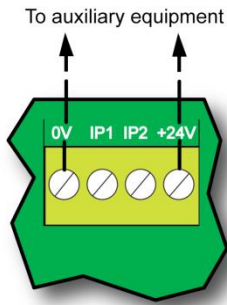

One fused 24Vdc output, rated at 100mA, is provided on the Main 1 or 2-Loop PCB (dependent on model) and can be used for supplying power to ancillary fire alarm equipment, e.g. relays. The output wiring should be connected to the terminal block marked +24V, as shown in figure 7 left.

5.15 Relay Output Wiring

Three volt-free relay output connections are provided on the Main 1 or 2-Loop PCB (dependent on model) - a failsafe fault output, which switches under any fault condition or total power failure, and two programmable auxiliary relay outputs. All three relays are capable of switching 1A @ 30Vdc.

DO NOT use these relays for switching Mains voltages.

Figure 8 – Relay Output Detail

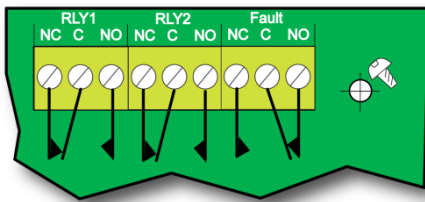

The two auxiliary outputs can be programmed using the panel's PC Tools to operate as required but their default operations are:

RLY1: Switches when any zone goes into fire; switches back when the panel is silenced.

RLY2: Switches when any zone goes into fire; switches back when the panel is reset.

The wiring for each output should be connected to the relevant connector block on the Main 1 or 2-Loop PCB (dependent on model), as shown in figure 8 above.

5.16 Remote PC Connection

Figure 9 – PC Connection

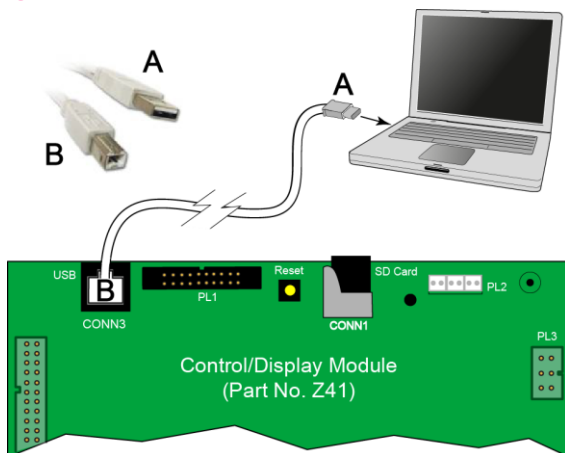

A 'galvanically - isolated' USB connector (CONN3) is provided on the Control/Display Module PCB for the connection of a Windows based PC, running programming software.

The recommended cable is a USB Type A male connector to USB Type B male connector.

ZFP PC Tools are available that allow quick and easy input of data, cause and effect programming, device and zone naming.

5.17 Printer Connection

Socket (PL3) is provided on the Control/Display Module PCB for optionally connecting an integrated serial printer. This allows printing of the panel's event and alarm log. **DO NOT** connect an external printer to this connector.

5.18 Connecting Mains to the Panel's PSU



THE PSU IS CLASS 1 EQUIPMENT AND MUST BE EARTHED.

The panel's EN 54-4 PSU is a Mains to regulated DC power supply providing 5A @ 24Vdc. Combining the functions of a PSU, battery charging unit and battery monitoring unit, it is fully compliant with EN 54-4:1997 + A1:2002 + A2:2006.

Remove the protective cover of the PSU and feed the Mains cable through the PSU's 20mm grommet. Terminate the Mains cable at the power supply's PCB connector block CONN1 (see figure 10 below). After terminating, refit and secure the cover.

DO NOT ATTEMPT TO CONNECT MAINS SUPPLY TO THE PSU UNTIL THE INSTALLATION IS COMPLETE AND THE PANEL IS READY TO BE TESTED.

Figure 10 – 5A PSU Layout and Mains Connection Details (with protective cover removed)

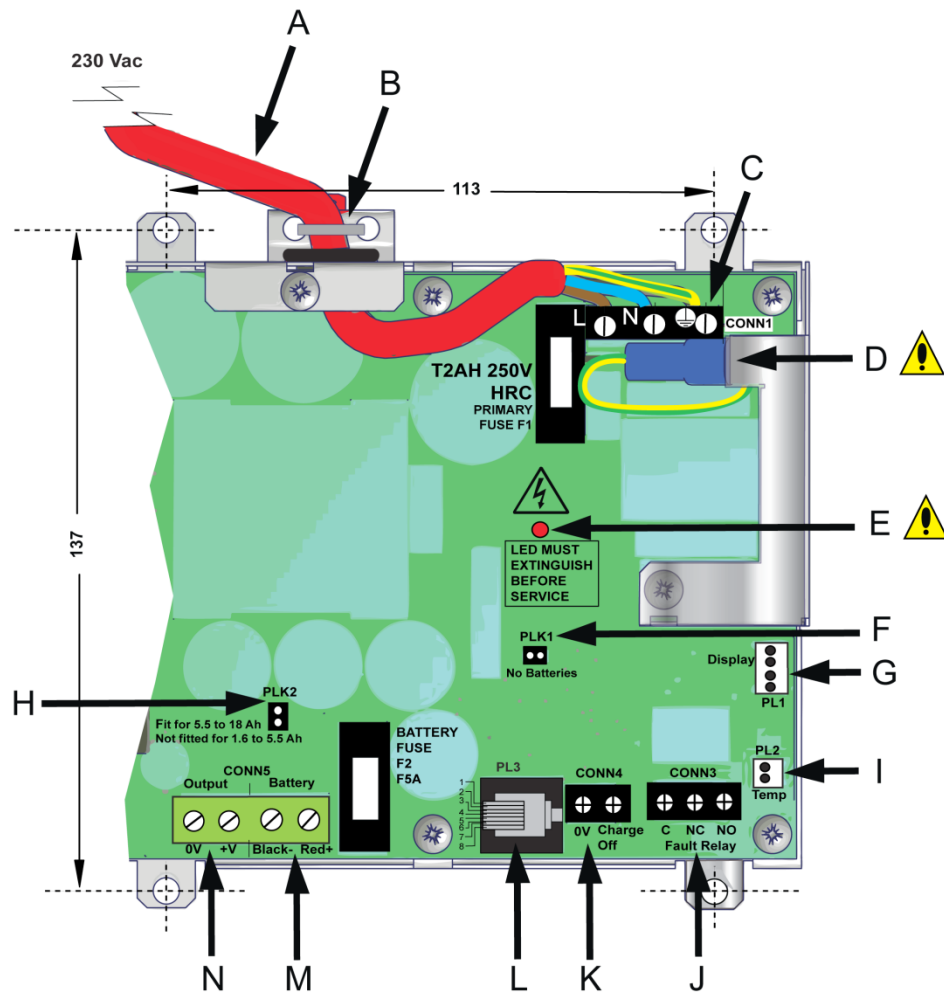

Figure 10 key:

A	Mains Cable Must be fire resistant, segregated from extra low voltage cables, and fed through the PSU's grommet.	H	Battery Charge Link (PLK2) Fitted for 7Ah to 38Ah (1A charge).
B	Cable Tie For cable management purposes, secure incoming cable using supplied tie.	I	Not used.
C	Mains Connector (CONN1) L=Live, N=Neutral, ⊕=Earth.	J	Fault Relay (CONN3)
D	PSU Earth Strap DO NOT operate equipment without connecting this strap as shown above.	K	Charge Off Input (CONN4)
E	Hazardous Voltage Present LED When lit red, hazardous voltages are present on the components and copper under the PSU's cover. DO NOT TOUCH UNTIL EXTINGUISHED!	L	OEM Equipment Connector (PL3) Connects to PL4 on Main 1 or 2-Loop PCB.
F	Battery Monitoring Link (PLK1) . Link must NOT be permanently fitted.	M	Battery Input (CONN5) See section 5.19.
G	Not used.	N	Supply Output (CONN6)

5.19 Connecting the Standby Batteries



CAUTION: There is a risk of explosion if an incorrect battery type is used. Always dispose of used batteries in accordance with the battery manufacturers' instructions.

Do not make the final battery connections until the installation wiring is complete and the panel is ready to be tested. One method of isolating battery power is to disconnect the battery link wire.

Two new, good quality and fully charged 12V valve regulated lead acid (VRLA) batteries are required as the emergency stand-by power supply for the panel.

The batteries should be connected in series and located in the bottom of the panel's enclosure, as shown in figure 11 below. Connect the 'Red' (+ve) and 'Black' (-ve) battery wires from the battery terminals to connector block CONN5 on the power supply's PCB. The (red and black) battery wires, (green) link wire and nylon cable ties are supplied in the panel's accessory pack. Secure the batteries into position using the cable ties.

The panel's sophisticated battery monitoring unit protects the batteries against deep discharge by activating a cut off circuit when the stand-by supply voltage reaches 21V approx. If batteries are not fitted, are discharged or in poor condition, a PSU fault will show at the panel.

The capacity of the batteries used will depend upon the required stand-by time. To calculate the batteries required for any given stand-by period, see the battery calculation guide in Appendix 5.

Figure 11 – Battery Connection Details

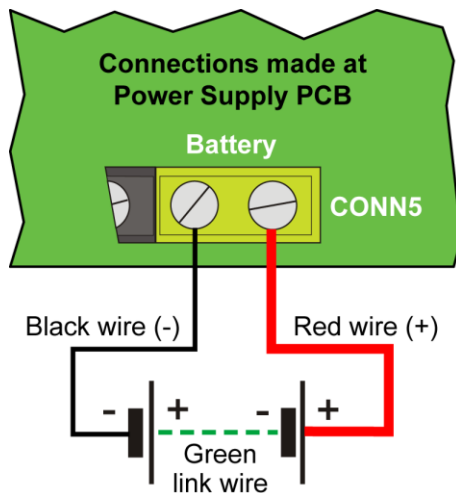

CAUTION! Inferior and New Batteries stored over 6 months.

The panel's PSU is an EN 54-4/A2 power supply and as such measures accurately the internal battery resistance down to a fraction of an ohm. The fault threshold is a function of EN 54-4 and as such cannot be changed, otherwise, it would NOT be a certifiable power supply. Batteries stored for long periods of time before use (especially new ones!), suffer a progressive degradation of internal resistance the longer they are kept off charge after manufacture. Contrary to popular opinion they DO NOT recover this degradation once re-charged. In order for the battery to recover it MUST be discharged and charged several times (more than once), each time you will see a reduction in the internal resistance.

Therefore, if you install one of these batteries AND it shows a fault AND you just leave it AND expect the fault to go away, it will not! In this instance it is not the charger at fault, it is the battery.

6 ‘Hi-NET’ MULTIPATH NETWORKING (Optional)

The ZFP’s network protocol allows the interconnection of up to 126 ZFP panels and compact controllers over a two-wire RS485 network. The ZFP network is a high integrity multipath network, i.e. ‘Hi-NET’.

To communicate over a network, each network node (panel or compact controller) requires a fitted ‘Hi-NET’ multipath network PCB. Compact controllers come with a network PCB fitted as standard.

6.1 Summary of Network Features

Feature	‘Hi-NET’ Multipath Network
ZFP ‘Hi-NET’ multipath network PCB Part No.:	ZHN (one required per network node)
Maximum number of network nodes:	126 (max. 64 x 8 loop panels)
Maximum cable length of network:	128km
Maximum cable length between nodes:	1km
Network protocol:	RS485
Network topology:	Ring configuration
Network wiring:	2 core screened cable, fire resistant (min. size 1mm ²). <i>Note: Optional fibre optic networking is also available (see section 6.5).</i>
Fault tolerant network (with a single wiring fault):	√ Yes
Accept Events (Fires, Faults, Disablements, Tests) over the network:	√ Yes
Accept Actions (Silence Sounders, ReSound Sounders, Reset Panel, etc.) over the network:	√ Yes
Share Zones, Input Groups, Output Groups, etc. over the network:	√ Yes
PC Tools available for programming Cause and Effects and site information over the network:	√ Yes

6.2 Fitting the Network PCB

A panel requires a ‘Hi-NET’ network PCB fitting, whilst compact controllers include one fitted as standard.

Important Note: Before installing the PCB, isolate the Mains supply and disconnect the panel’s battery back-up supply.

Fit the ‘Hi-NET’ network PCB as shown in figure 12 below. Items supplied with the PCB include plastic mounting rails, retaining screws and a 10-way wiring loom (ZLOOM4).

Note a Main 2-Loop PCB is shown connected to the network PCB in the example below.

Figure 12 – Fitting the ‘Hi-NET’ Network PCB

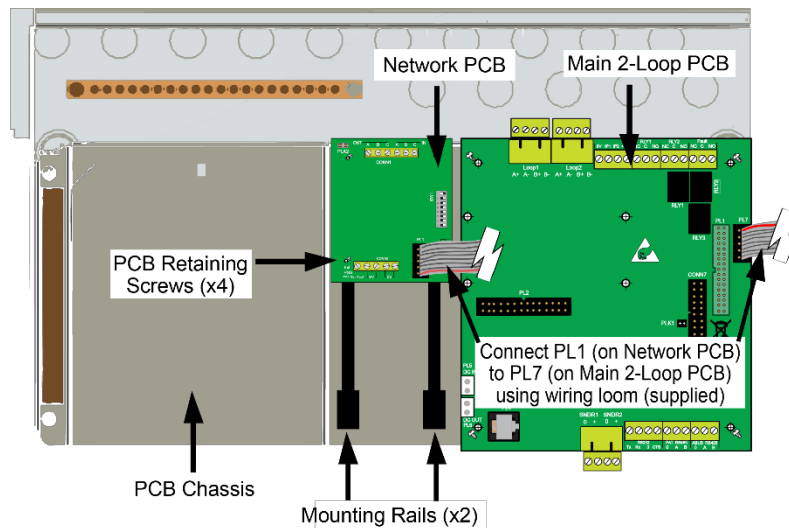

6.3 'Hi-NET' Multipath Network Wiring

Network wiring must be installed in accordance with all applicable national, regional or local standards. In the UK this is BS 7671 IEE Wiring Regulations and BS 5839-1, Fire detection and alarm systems for buildings: Code of practice for system design, installation and maintenance. See Cabling Requirements, section 4.

Nodes are connected on a ring circuit using 2 core, fire resistant, screened cable (min. size 1mm²).

From node to node, connect A (IN) to A (OUT), B (IN) to B (OUT) and C (IN) to C (OUT) on the 'Hi-NET' network PCB's connector CONN1. Note that terminals A and B are for data comms and terminal C is for earth screens. The PCB has onboard status indicators.

At one networked panel only, terminate the earth screen to the panel's earth bar. This earth bar must also be connected to terminal C (OUT) at this panel. Panel 1 (Node 1) is shown connected to earth in the diagrams as an example.

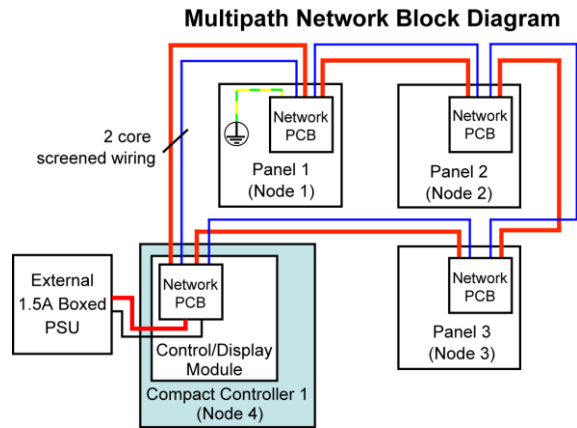

PLK2 is the RS485 termination link and is fitted at every node on the network. Each segment of the cable is in effect its own RS485 network.

Figure 13 - 'Hi-NET' Multipath Network Wiring

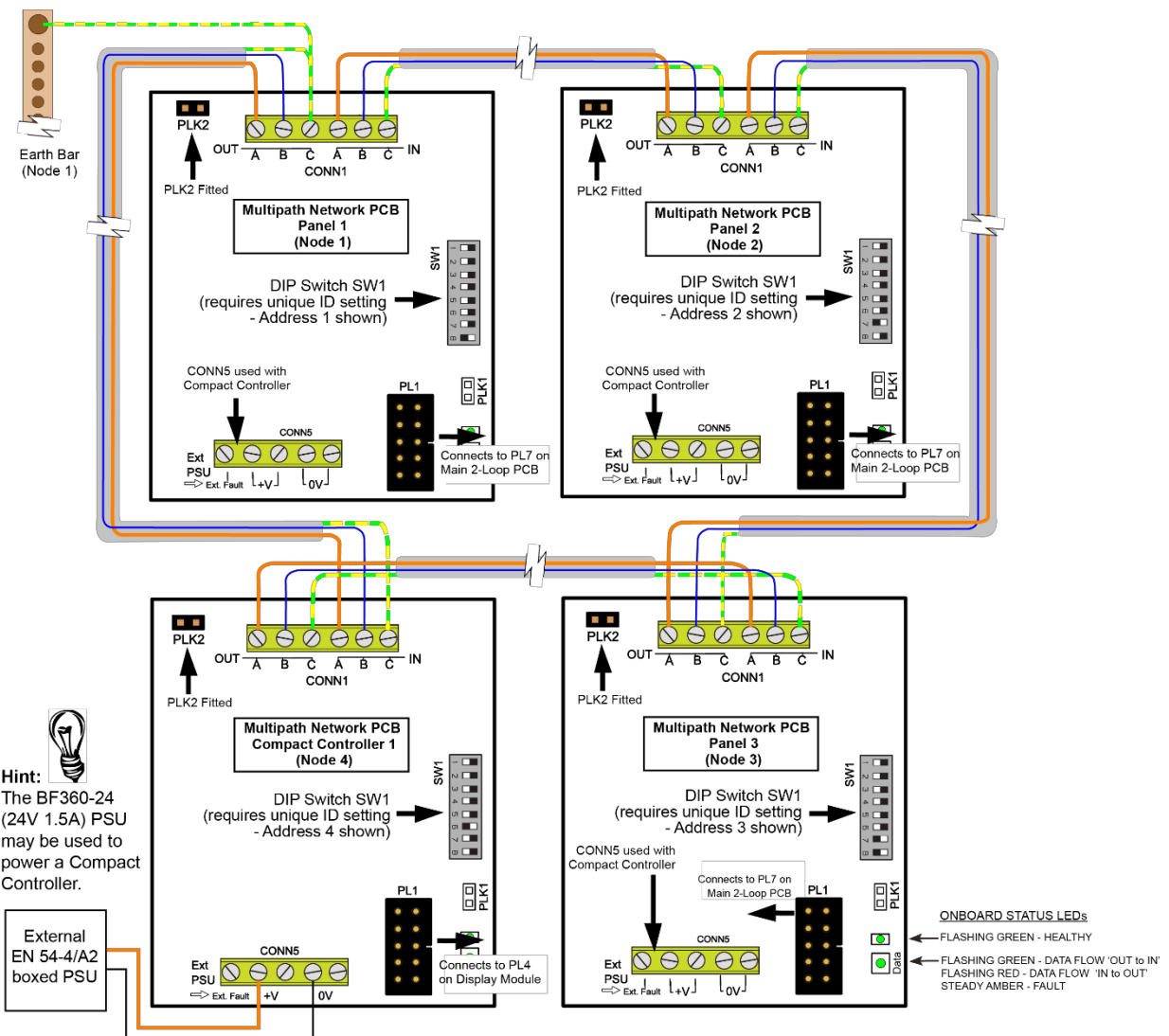

ZFP Networkable Analogue Addressable Fire Alarm Panel

6.4 'Hi-NET' DIP Switch Address Settings

Each network node (panel or compact controller) requires a unique ID number (1 up to 126) set using the DIP switch (SW1) on the 'Hi-NET' network PCB. The same unique ID number also needs to be assigned at each individual node using the Setup Networking menu option at access level 3 (see 'Assigning ID Addresses at Access Level 3', section 6.6).

We advise that the DIP switch address set is the same number as the panel in which the Hi-NET PCB is housed, i.e. Address 1 is Panel 1, Address 2 is Panel 2, etc.

Each PCB's address is set using Bits 2 to 8 on the DIP switch (SW1). Bit 1 is for future use.

DIP switch up (ON) = 1; DIP switch down (OFF) = 0.
DO NOT use addresses 0 or 127.

Use a small screwdriver to set the switches and ensure the switches are fully pushed home, up or down.

Refer to table below for address settings.

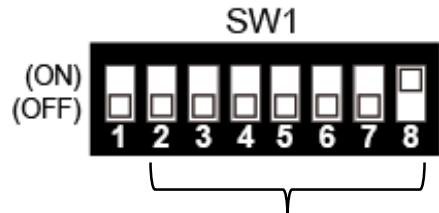

Use Bits 2-8 on the DIP switch to select the PCB's address (1 set in above example).

Addr	DIP position	Addr	DIP position	Addr	DIP position	Addr	DIP position
	2 3 4 5 6 7 8		2 3 4 5 6 7 8		2 3 4 5 6 7 8		2 3 4 5 6 7 8
1	0 0 0 0 0 0 1	34	0 1 0 0 0 1 0	67	1 1 0 0 0 0 1	96	0 0 0 0 0 1 1
2	0 0 0 0 0 1 0	35	1 1 0 0 0 1 0	68	0 0 1 0 0 0 1	97	1 0 0 0 0 1 1
3	0 0 0 0 0 1 1	36	0 0 1 0 0 1 0	69	1 0 1 0 0 0 1	98	0 1 0 0 0 1 1
4	0 0 0 0 1 0 0	37	1 0 1 0 0 1 0	70	0 1 1 0 0 0 1	99	1 1 0 0 0 1 1
5	0 0 0 0 1 0 1	38	0 1 1 0 0 1 0	71	1 1 1 0 0 0 1	100	0 0 1 0 0 1 1
6	0 0 0 0 1 1 0	39	1 1 1 0 0 1 0	72	0 0 0 1 0 0 1	101	1 0 1 0 0 1 1
7	0 0 0 0 1 1 1	40	0 0 0 1 0 1 0	73	1 0 0 1 0 0 1	102	0 1 1 0 0 1 1
8	0 0 0 1 0 0 0	41	1 0 0 1 0 1 0	74	0 1 0 1 0 0 1	103	1 1 1 0 0 1 1
9	0 0 0 1 0 0 1	42	0 1 0 1 0 1 0	75	1 1 0 1 0 0 1	104	0 0 0 1 0 1 1
10	0 0 0 1 0 1 0	43	1 1 0 1 0 1 0	76	0 0 1 1 0 0 1	105	1 0 0 1 0 1 1
11	0 0 0 1 0 1 1	44	0 0 1 1 0 1 0	77	1 0 1 1 0 0 1	106	0 1 0 1 0 1 1
12	0 0 0 1 1 0 0	45	1 0 1 1 0 1 0	78	0 1 1 1 0 0 1	107	1 1 0 1 0 1 1
13	0 0 0 1 1 0 1	46	0 1 1 1 0 1 0	79	1 1 1 1 0 0 1	108	0 0 1 1 0 1 1
14	0 0 0 1 1 1 0	47	1 1 1 1 0 1 0	80	0 0 0 0 1 0 1	109	1 0 1 1 0 1 1
15	0 0 0 1 1 1 1	48	0 0 0 0 1 1 0	81	1 0 0 0 1 0 1	110	0 1 1 1 0 1 1
16	0 0 0 0 1 0 0	49	1 0 0 0 1 1 0	82	0 1 0 0 1 0 1	111	1 1 1 1 0 1 1
17	1 0 0 0 1 0 0	50	0 1 0 0 1 1 0	83	1 1 0 0 1 0 1	112	0 0 0 0 1 1 1
18	0 1 0 0 1 0 0	51	1 1 0 0 1 1 0	84	0 0 1 0 1 0 1	113	1 0 0 0 1 1 1
19	1 1 0 0 1 0 0	52	0 0 1 0 1 1 0	85	1 0 1 0 1 0 1	114	0 1 0 0 1 1 1
20	0 0 1 0 1 0 0	53	1 0 1 0 1 1 0	86	0 1 1 0 1 0 1	115	1 1 0 0 1 1 1
21	1 0 1 0 1 0 0	54	0 1 1 0 1 1 0	87	1 1 1 0 1 0 1	116	0 0 1 0 1 1 1
22	0 1 1 0 1 0 0	55	1 1 1 0 1 1 0	88	0 0 0 1 1 0 1	117	1 0 1 0 1 1 1
23	1 1 1 0 1 0 0	56	0 0 0 1 1 1 0	89	1 0 0 1 1 0 1	118	0 1 1 0 1 1 1
24	0 0 0 1 1 0 0	57	1 0 0 1 1 1 0	90	0 1 0 1 1 0 1	119	1 1 1 0 1 1 1
25	1 0 0 1 1 0 0	58	0 1 0 1 1 1 0	91	1 1 0 1 1 0 1	120	0 0 0 1 1 1 1
26	0 1 0 1 1 0 0	59	1 1 0 1 1 1 0	92	0 0 0 1 1 0 1	121	1 0 0 1 1 1 1
27	1 1 0 1 1 0 0	60	0 0 1 1 1 1 0	93	1 0 0 1 1 0 1	122	0 1 0 1 1 1 1
28	0 0 1 1 1 0 0	61	1 0 1 1 1 1 0	94	0 1 0 1 1 0 1	123	1 1 0 1 1 1 1
29	1 0 1 1 1 0 0	62	0 1 1 1 1 1 0	95	1 1 0 1 1 0 1	124	0 0 1 1 1 1 1
30	0 1 1 1 1 0 0	63	1 1 1 1 1 1 0			125	1 0 1 1 1 1 1
31	1 1 1 1 1 0 0	64	0 0 0 0 0 0 1			126	0 1 1 1 1 1 1
32	0 0 0 0 0 1 0	65	1 0 0 0 0 0 1				
33	1 0 0 0 0 1 0	66	0 1 0 0 0 0 1				

6.5 Fibre Network Wiring for 'Hi-NET'

Overview

This section details how to connect networked ZFP panels using fibre optic connections.

Features

Uses RS485 serial Fibre Optic Transceivers; each 9V-40V DC power input, consumption 2W. Two Fibre Optic Transceivers required per ZFP panel.

Uses duplex, multi-mode, optical fibre – maximum distance 2km, 850nm wavelength.

Provides a reliable data network and increases the transfer function of the system.

Fibre Equipment Required

Fibre Optic Transceiver x 2 (Part No. BF356).

SC optical fibre connectors (not supplied).

Optical fibre (not supplied).

External box (not supplied) to house fibre transceivers / connectors, PSU and batteries.

EN 54-4/A2 PSU c/w 7Ah back-up batteries (not supplied) – 1 set required per ZFP panel.



Hint: We recommend using an EN 54-4 compliant power supply for this application, e.g. the BF360-12 (24V 2A) PSU.

C-TEC supply a range of power supplies, third-party certified to EN 54-4/A2. Contact your distributor for details.

Wiring the Fibre Network

Connect the fibre equipment, as shown below.

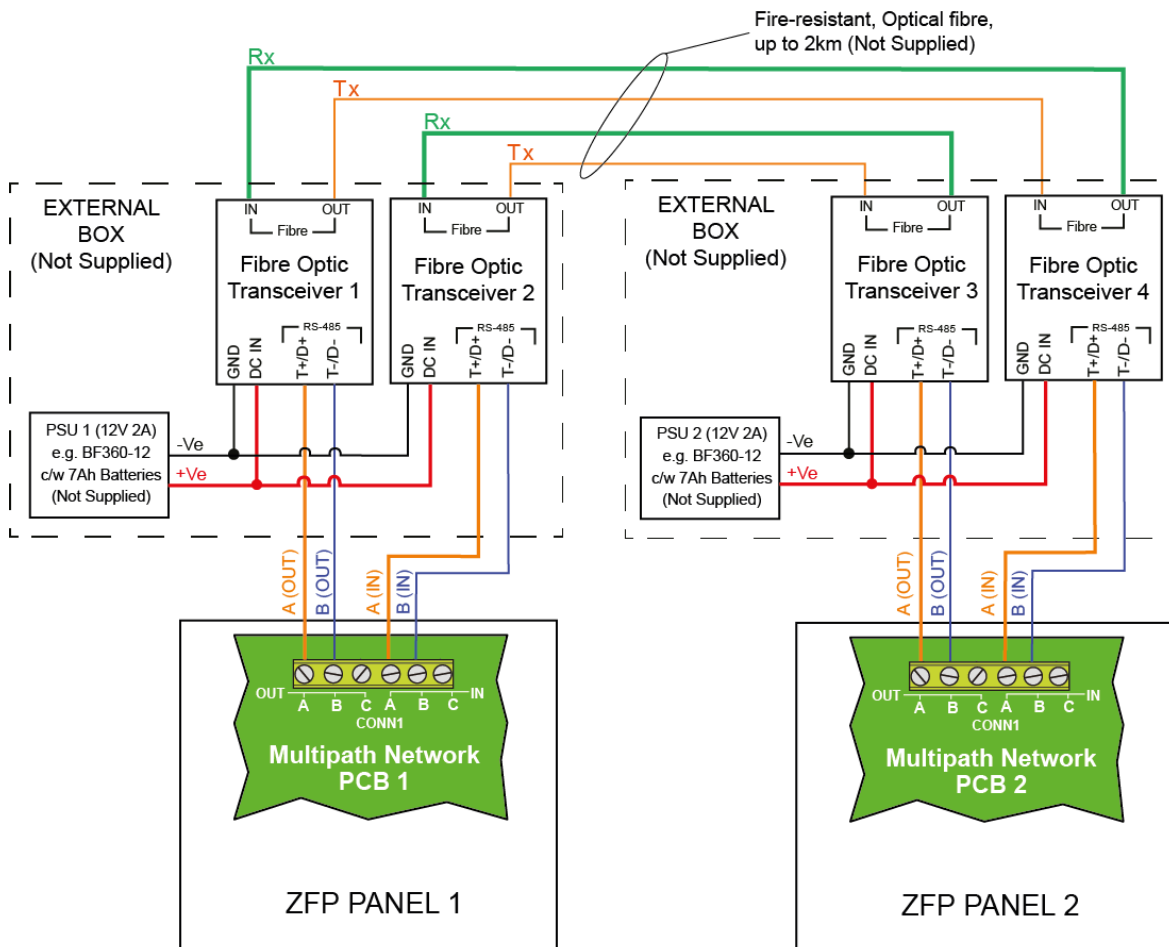

6.6 Assigning ID Addresses at Access Level 3

At each network node (normally a panel) in turn, at the node's LCD touchscreen, enter:
Access Level 3 > Commissioning Functions > Setup Networking. The window shown below left appears.

Press the  button (shown below left) and the window shown below right appears.

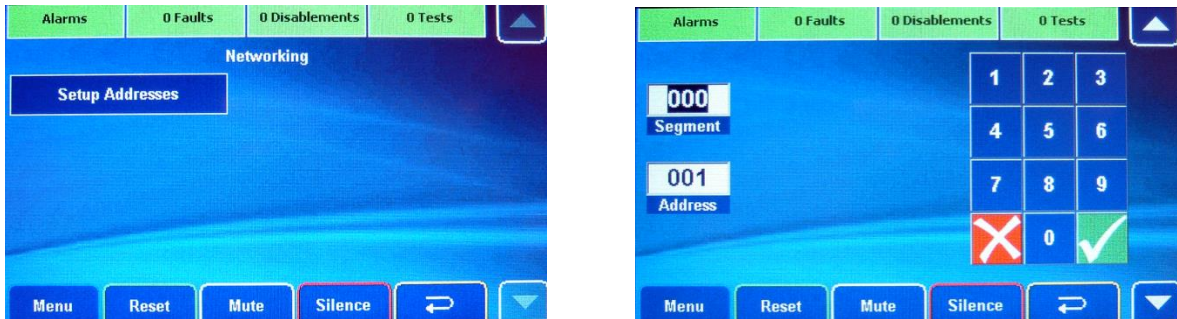

The **Segment** field relates to a batch of panel addresses. Segment 000 (displayed by default) denotes a non-network system, Segment 001, 002, 003, etc. denote separate segments of a networked system.

The **Address** field is the node's unique ID address within a networked system and is split up into segment and node (within segment addresses).

For example, in a multipath system, you may have up to 64 networked nodes (addresses 001 to 064) in Segment 001 and another 62 networked nodes (addresses 065 to 126) in Segment 002.

- Enter the segment number in the Segment field using the touchscreen's keypad, e.g. 001.
- Enter the node's unique ID number in the Address field using the touchscreen's keypad, e.g. 001, 002, 003, etc. For multipath systems, ensure this is the same ID that has been set using the DIP switch (SW1) in that particular panel.
- Press the  button to confirm and exit.
- Repeat this procedure at all other networked nodes.

7 A-BUS (Optional)

A-Bus enhances the functionality of the ZFP system by connecting peripheral PCBs which provide additional relay outputs, digital I/O, sounder circuits and detection zones.

The A-Bus RS485 network protocol allows the interconnection of up to 15 A-Bus PCBs per Main 1 or 2-Loop PCB (dependent on ZFP model) using 2 core screened cable (plus 2 core for power). A-Bus PCBs are normally installed within a ZFP panel but can also work up to a distance of 1km for non-EN 54-2 functions. Two A-Bus PCB sizes are available; full and half size. If required, a full size PCB (Relay & Digital I/O only) can be scored in the middle to produce a half size PCB. Programming A-Bus PCBs using ZFP PC Tools is detailed in Document No. DFU5000505.

7.1 Z11/Z12 Relay PCB and Z13/Z14 Digital I/O PCB Features

Feature	Details
A-Bus PCBs:	ZFP 4-way Relay PCB (half size). Part No. Z11. ZFP 8-way Relay PCB (full size). Part No. Z12. ZFP 8-way Digital I/O PCB (half size). Part No. Z13. ZFP 16-way Digital I/O PCB (full size). Part No. Z14.
Cabling:	2 core screened cable (plus 2 core for power).
Protocol:	RS485, 19200 BAUD, 8 Data, no Parity, 1 stop bit.
Installation:	PCBs normally installed within a ZFP panel but may be extended up to 1km for non-EN 54-2 functions.
Number of PCBs:	Connect up to 15 A-Bus PCBs per Main 1 or 2-Loop PCB (dependent on model).
PCB sizes (mm):	Half size: 80 w x 70 h x 30 d. Full size: 80 w x 150 h x 30 d.
Powered from:	Main 1 or 2-Loop PCB (dependent on model) or an external EN 54-4/A2 PSU (<u>not supplied</u>).
Common features:	<ul style="list-style-type: none"> • 24V supply inputs. • ABUS RS485 connections (B, A, 0) to Main 1 or 2-Loop PCB. • Comms connections (PL1/PL2); Power In/Power Out connections (PL5/PL6). • 15 available addresses (set using DIP switch SW1, see section 7.2). • Isolated RS485 multi drop. • LED indication for polling and power. • Standard 5mm fixed PCB connectors, accept up to 2.5mm² cable.
Relay PCB (Z11/Z12) features: (8-way PCB shown below)	<ul style="list-style-type: none"> • Common features (as above). • 1A 30V single pole contacts. • Full size PCB can be scored in the middle to produce a half size PCB. • Full size provides 8-way option; half size provides 4-way option. • Each relay output is programmable using ZFP PC Tools (see DFU5000505). • Separate LED indication provided for each relay.



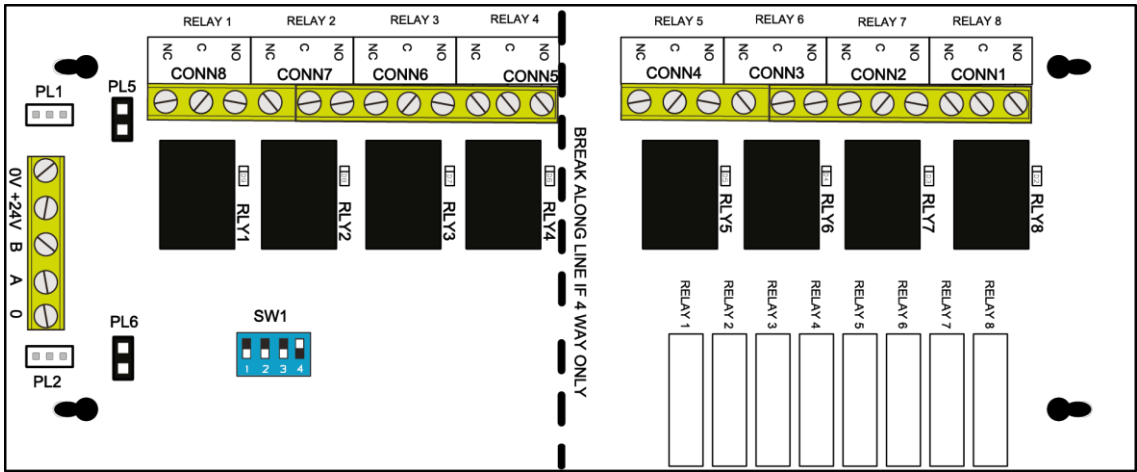

ZFP Networkable Analogue Addressable Fire Alarm Panel

Feature	Details
Digital I/O PCB (Z13/Z14) features: (16-way PCB shown below) <div style="text-align: center; margin: 10px 0;"> </div>	<ul style="list-style-type: none"> Common features (as above). Open collector outputs (100mA sink). Full size PCB can be scored in the middle to produce a half size PCB. Full size provides 16-way option; half size provides 8-way option. Each I/O is programmable using ZFP PC Tools (see DFU5000505). 1 LED for any input; 1 LED for any output.
<p>Digital I/O Terminations</p> <p>Note: Terminations to 'IO1' is shown as an example below, other I/O terminals to be wired similarly.</p> <div style="display: flex; justify-content: space-around;"> <div style="border: 1px dashed gray; padding: 5px; width: 45%;"> <p style="font-size: small;">- Used as an input.</p> <p style="font-size: small;">- Active when switched to GND.</p> <p style="font-size: small;">- Current (I) = 26mA per active input.</p> <p style="font-size: x-small; text-align: center;">User switch/relay contact, etc.</p> </div> <div style="border: 1px dashed gray; padding: 5px; width: 45%;"> <p style="font-size: small;">- Used as an output.</p> <p style="font-size: small;">- Open collector output connections.</p> <p style="font-size: small;">- Remote +V must not be greater than supply V on A-Bus PCB.</p> </div> </div>	

7.2 A-Bus DIP Switch Address Settings

Each PCB's address is set using Bits 1 to 4 on the 4-way DIP switch (SW1).
 DIP switch up (ON) = 1, DIP switch down (OFF) = 0. **DO NOT** use address 0.
 Use a small screwdriver to set the switches and ensure the switches are fully pushed home, up or down.
 Refer to table below for address settings.

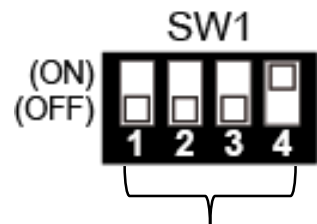

Use Bits 1-4 on the DIP switch to select the PCB's address (1 set in above example).

Address	DIP position	Address	DIP position
	1 2 3 4		1 2 3 4
1	0 0 0 1	9	1 0 0 1
2	0 0 1 0	10	1 0 1 0
3	0 0 1 1	11	1 0 1 1
4	0 1 0 0	12	1 1 0 0
5	0 1 0 1	13	1 1 0 1
6	0 1 1 0	14	1 1 1 0
7	0 1 1 1	15	1 1 1 1
8	1 0 0 0		

Note: The DIP switch address set for each PCB (maximum of 15 addresses) should be the same address set using the ZFP PC Tools (see Document No. DFU5000505).

ZFP Networkable Analogue Addressable Fire Alarm Panel

7.3 Z15 Sounder PCB Features

Feature	Details
A-Bus PCB (Z15):	ZFP 4-way Conventional Sounder PCB (full size). Part No. Z15.
Cabling:	2 core screened cable (plus 2 core for power).
Protocol:	RS485, 19200 BAUD, 8 Data, no Parity, 1 stop bit.
Powered from:	Note: We recommend an Aux EN 54-4/A2 PSU (external to the ZFP panel – <u>not supplied</u>). The PCB terminal labelled 'Ex' is used to report a fault from the Aux PSU. It is triggered from an active IO signal from an open collector (O/C), or volt-free (with 0V common) relay O/P.
No. of Sounder Circuits:	4 x 1A outputs. Programmable and monitored.
Installation:	PCBs normally installed within a ZFP panel but may be extended up to 1km for non-EN 54-2 functions.
Number of PCBs:	Connect up to 15 A-Bus PCBs per Main 1 or 2-Loop PCB (dependent on model).
PCB size (mm):	67 w x 165 h x 17 d.
Common features:	<ul style="list-style-type: none"> • 24V supply inputs. • ABUS RS485 connections (B, A, 0) to Main 1 or 2-Loop PCB. • Comms connections (PL4/PL5); Power In/Power Out connections (PL2/PL3). • 15 available addresses (set using DIP switch SW1, see section 7.2). • Isolated RS485 multi drop. • LED indication for polling and power. • Standard 5mm fixed PCB connectors, accept up to 2.5mm² cable.
Sounder PCB (Z15) features: (shown below)	<ul style="list-style-type: none"> • Common features (as above). • 4 x 1A Monitored sounder circuits. • Each sounder output is programmable using ZFP PC Tools (see DFU5000505). • Separate LED indication provided for each sounder circuit.

ZFP Networkable Analogue Addressable Fire Alarm Panel

7.4 Z16 Zone Sounder PCB Features

Feature	Details
A-Bus PCB (Z16):	ZFP Detection Zone & Conventional Sounder PCB (full size). Part No. Z16.
Cabling:	2 core screened cable (plus 2 core for power).
Protocol:	RS485, 19200 BAUD, 8 Data, no Parity, 1 stop bit.
Powered from:	Note: We recommend an Aux EN 54-4/A2 PSU (external to the ZFP panel – <u>not supplied</u>). The PCB terminal labelled 'Ex' is used to report a fault from the Aux PSU. It is triggered from an active IO signal from an open collector (O/C), or volt-free (with 0V common) relay O/P.
No. of Detection Zones:	4 x Conventional detection zones, each with a maximum of 10 conventional devices.
No. of Sounder Circuits:	2 x 1A outputs. Programmable and monitored.
Installation:	PCBs normally installed within a ZFP panel but may be extended up to 1km for non-EN 54-2 functions.
Number of PCBs:	Connect up to 15 A-Bus PCBs per Main 1 or 2-Loop PCB (dependent on model).
PCB size (mm):	67 w x 165 h x 17 d.
Common features:	<ul style="list-style-type: none"> • 24V supply inputs. • ABUS RS485 connections (B, A, 0) to Main 1 or 2-Loop PCB. • Comms connections (PL2/PL3); Power In/Power Out connections (PL5/PL6). • 15 available addresses (set using DIP switch SW1, see section 7.2). • Isolated RS485 multi drop. • LED indication for polling and power. • Standard 5mm fixed PCB connectors, accept up to 2.5mm² cable.
Zone Sounder PCB (Z16) features: (shown below)	<ul style="list-style-type: none"> • Common features (as above). • 4 x Conventional zone inputs. • 2 x 1A Monitored sounder outputs. • Each circuit is programmable using ZFP PCTools (see DFU5000505). • Separate LED indication provided for each zone and sounder circuit.



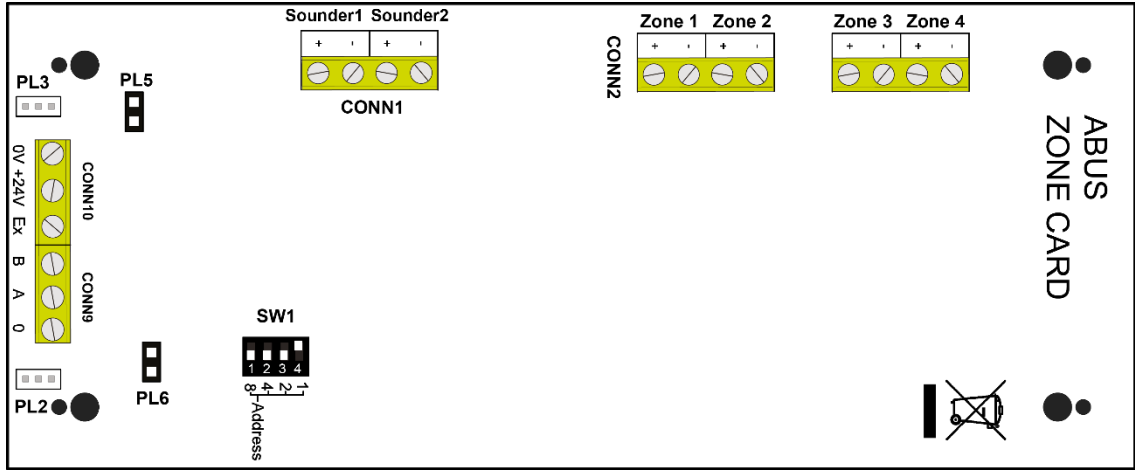

7.5 Fitting A-Bus PCBs

Important Note: Before installing the PCBs, isolate the Mains supply and disconnect the panel’s battery back-up supply.

Fit the A-Bus PCBs as shown in the examples below. Items supplied with the PCB include plastic mounting rails and retaining screws.

Flat Chassis Layout Example
(shown right)

Note that a Main 2-Loop PCB, Relay PCB and Digital I/O PCB are shown in this example.

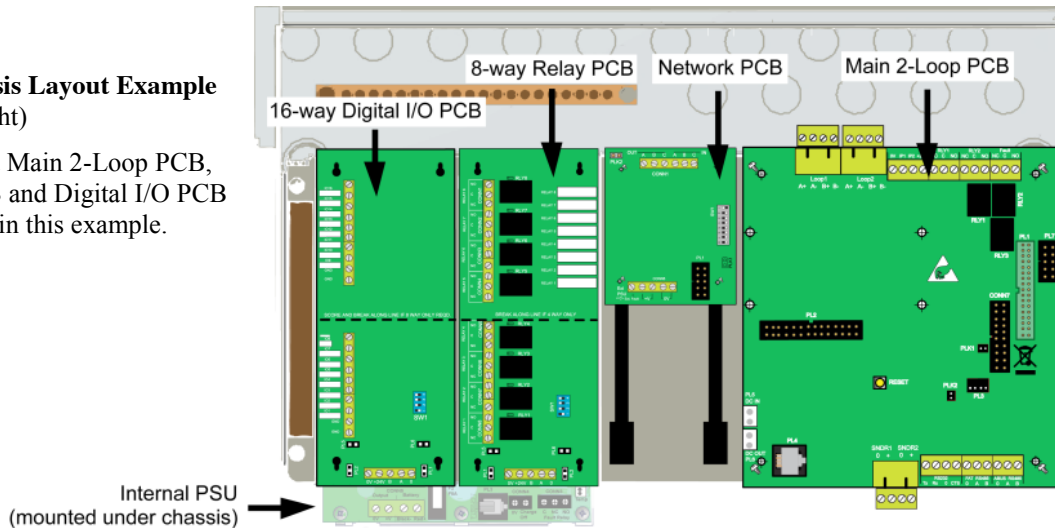

Stepped Chassis Layout Example (shown below)

Note that a Main 2-Loop PCB, Relay PCB and Digital I/O PCB are shown in the example below.

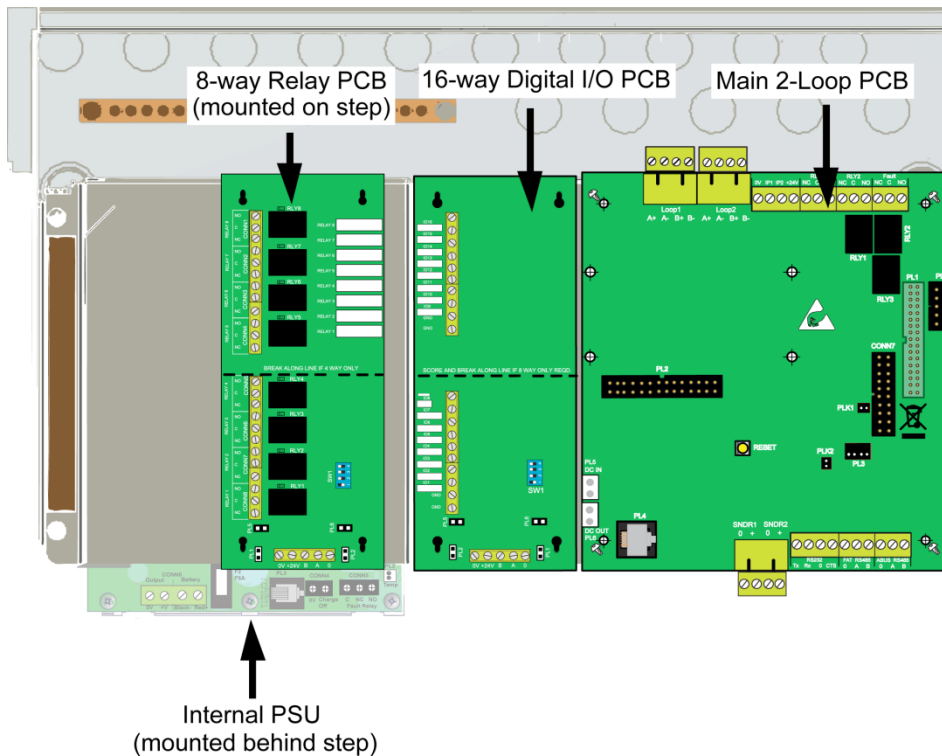

Note 1: On a standard 1 slot cabinet, only a stepped chassis can be used.

Note 2: Only one full size PCB can be fitted on a step (an 8-way Relay PCB is shown in the example above).

Note 3: Due to clearance requirements, a PCB cannot be fitted on a step if a printer module is fitted on the front of the same stepped chassis.

7.6 A-Bus Wiring

A-Bus wiring must be installed in accordance with all applicable national, regional or local standards. In the UK this is BS 7671 IEE Wiring Regulations and BS 5839-1, Fire detection and alarm systems for buildings: Code of practice for system design, installation and maintenance. See Cabling Requirements, section 4.

Note that alternative power supply connections, to those shown below, are available on the A-Bus PCBs.

Figure 14 – Z11/Z12 Relay PCB and Z13/Z14 Digital I/O PCB Wiring

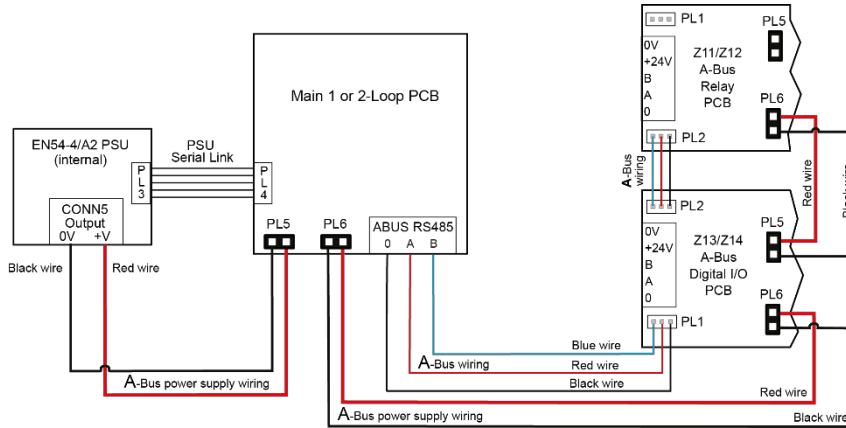
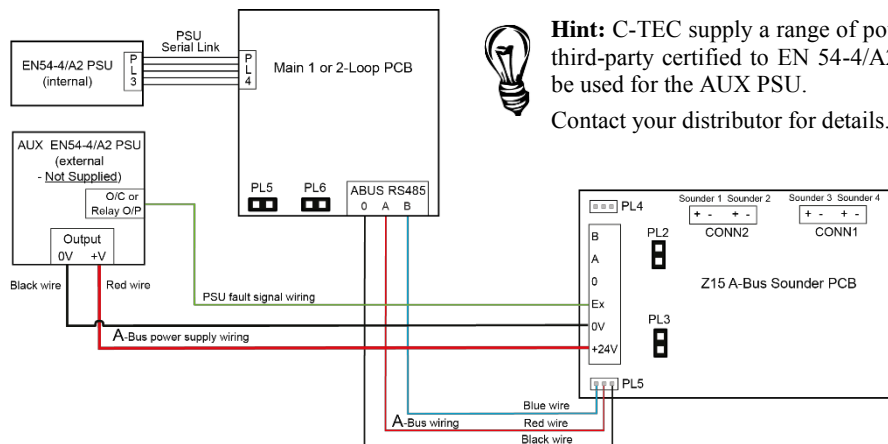

Figure 15 – Z15 Sounder PCB Wiring



Hint: C-TEC supply a range of power supplies, third-party certified to EN 54-4/A2 which may be used for the AUX PSU.

Contact your distributor for details.

Note: The Z15 terminal labelled 'Ex' is used to report a fault from the AUX (external) PSU. It is triggered from an active IO signal from an open collector (O/C), or volt-free (with 0V common) relay O/P. If an AUX (external) PSU is not used, a link must be fitted between PCB terminals labelled 'Ex' and '0V'. Correct polarity must be observed.

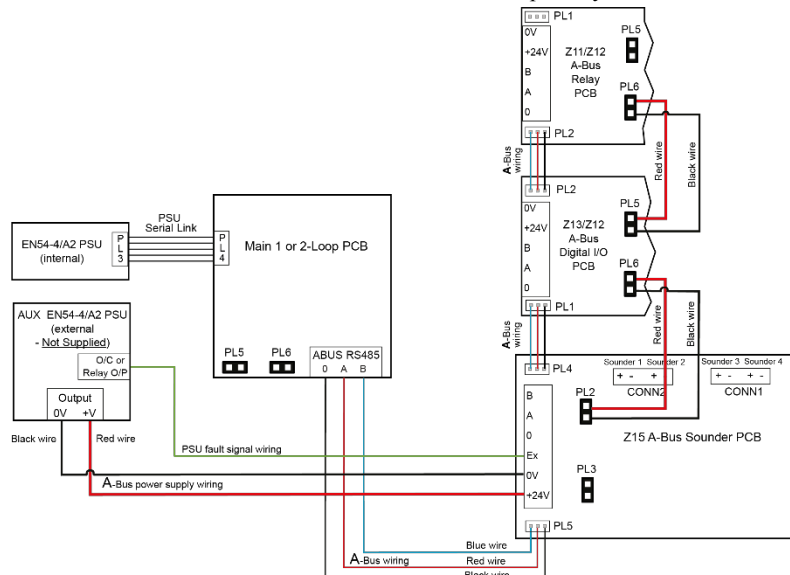

ZFP Networkable Analogue Addressable Fire Alarm Panel

Figure 16 – Z16 Zone Sounder PCB Wiring

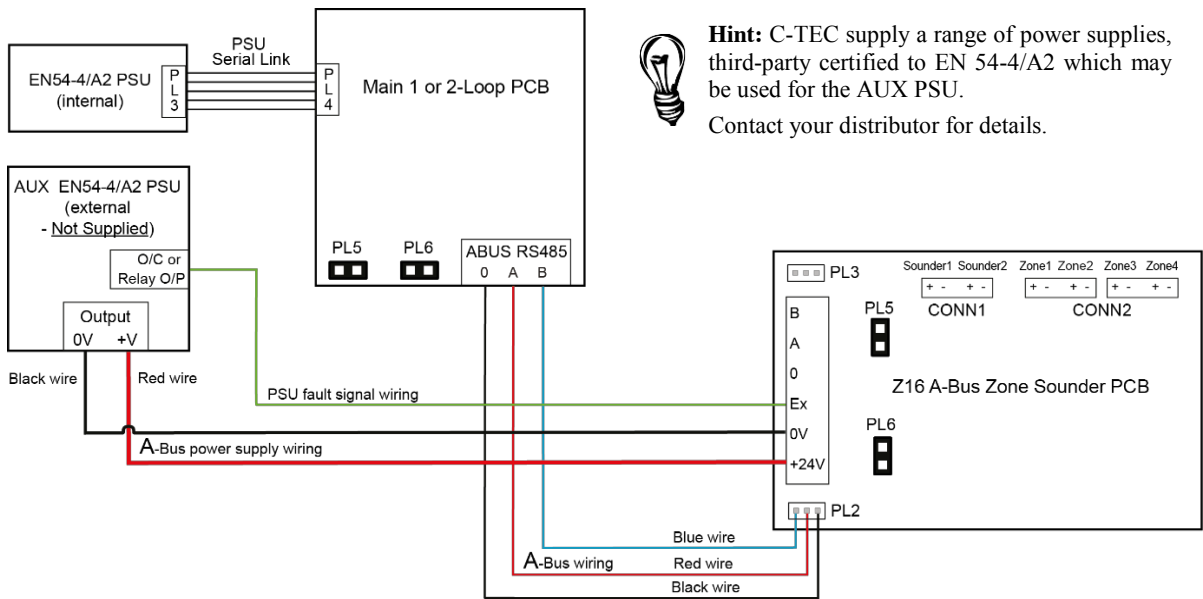

Hint: C-TEC supply a range of power supplies, third-party certified to EN 54-4/A2 which may be used for the AUX PSU. Contact your distributor for details.

Note: The Z16 terminal labelled 'Ex' is used to report a fault from the AUX (external) PSU. It is triggered from an active IO signal from an open collector (O/C), or volt-free (with 0V common) relay O/P. If an AUX (external) PSU is not used, a link must be fitted between PCB terminals labelled 'Ex' and '0V'. Correct polarity must be observed.

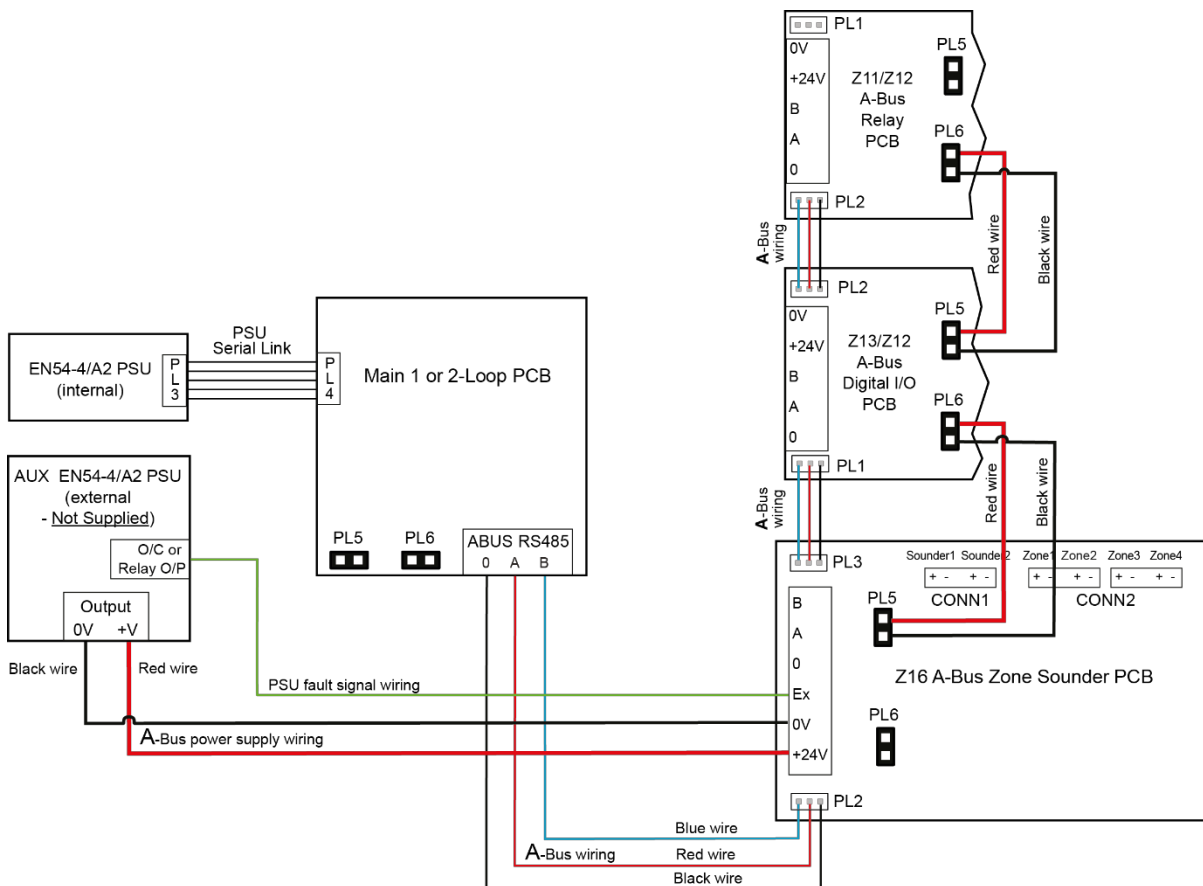

7.7 Z15 and Z16 Conventional Sounder Circuit(s) Wiring

Four conventional sounder circuits are provided on the Z15 A-Bus Sounder PCB and two conventional sounder circuits are provided on the Z16 A-Bus Zone Sounder PCB. Each circuit has a maximum rating of 1A. If a full complement of sounders or bells are to be used, split them equally across all circuits.

Connect each sounder circuit to the terminals labelled Sounder 1 (Z15 & Z16), Sounder 2 (Z15 & Z16), Sounder 3 (Z15 only) & Sounder 4 (Z15 only), as shown in Figure 17 below, and terminate earth screens at the back box earth bar.

Note: ALWAYS make sure the 6k8, EOL resistors (supplied) are fitted across the terminals of the last sounder on each circuit to allow the wiring to be monitored for open and short circuit faults. If a sounder circuit is unused, you must still connect the resistor at the PCB terminals.

Figure 17 – Z16 Conventional Sounder Circuit Connections

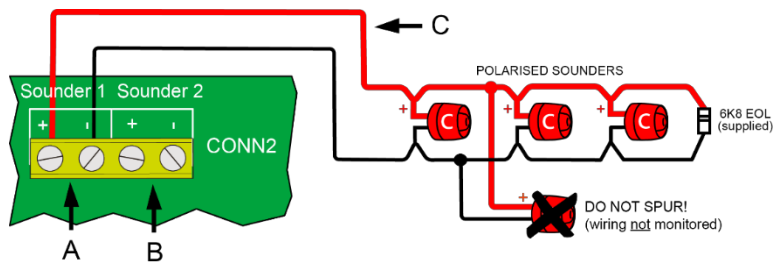

- A – Conventional Sounder 1 circuit connector (+, -).
- B – Additional Sounder 2 circuit connector (+, -). Wiring not shown.
- C – Sounder circuit cable (fire resistant).

7.8 Z16 Conventional Zone Circuit(s) Wiring

Four conventional zone circuits are provided on the Z16 A-Bus Zone Sounder PCB, each circuit may have a maximum number of 10 devices fitted.

Connect each zone circuit to the terminals marked Zone 1, Zone 2, Zone 3 & Zone 4, as shown in Figure 18 below, and terminate earth screens at the back box earth bar.

Note: ALWAYS make sure the four, 0.47µF 50V, end-of-line (EOL) capacitors (supplied) are fitted across the terminals of the last device on each circuit to allow the wiring to be monitored for open and short circuit faults. If a zone circuit is unused, you must still connect the capacitor at the PCB terminals.

Detector bases with integral continuity diodes must be used to ensure manual call points remain operational when a detector head is removed from its base. Manual call points with integral resistors must be used to prevent a short circuit fault occurring instead of a fire condition when activated.

Figure 18 – Z16 Conventional Zone Circuit Connections

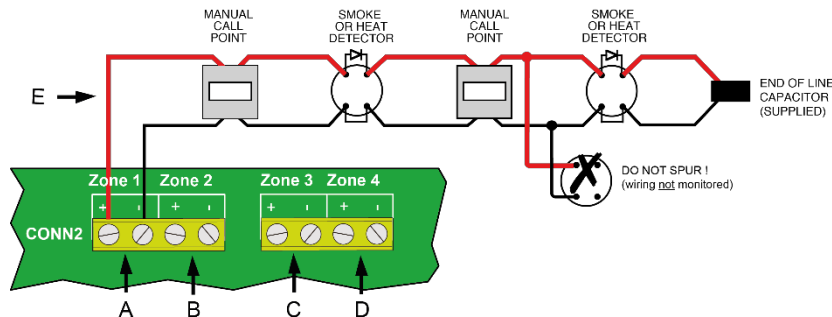

- A – Conventional Zone 1 circuit connector (+, -).
- B – Additional Zone 2 circuit connector (+, -). Wiring not shown.
- C – Additional Zone 3 circuit connector (+, -). Wiring not shown.
- D – Additional Zone 4 circuit connector (+, -). Wiring not shown.
- E – Zone circuit cable (fire resistant).

8 TOUCHSCREEN, INDICATORS & CONTROLS

Note that information on the panel's touchscreen, indicators and controls can be found in the separate User Manual (Document No. DFU5000501).

9 COMMISSIONING & PROGRAMMING

EN54 Compliance Statement

THIS COMPLIANCE STATEMENT IS FOR AUTHORISED SYSTEM ENGINEERS FAMILIAR WITH ANALOGUE FIRE ALARM SYSTEMS AND FIRE ALARM STANDARDS. ENSURE YOU HAVE ATTENDED C-TEC'S AUTHORISED TRAINING COURSE BEFORE USING THE PANEL'S PCTOOLS.

The 'out-of-the-box' fire alarm panel is fully compliant with the requirements of EN54-2 (Fire detection and fire alarm systems, control and indicating equipment) and EN54-4 (Fire detection and fire alarm systems, power supply equipment) and is 3rd party certified as meeting these standards.



Please note, the Engineering Functions listed below, go beyond the scope of EN54-2. DO NOT affix the EN54 approval label (supplied) to the front of the panel if it has been configured to operate in a way that would make it non-compliant with the requirements of EN54-2.

- A single delay time shall not exceed 10 minutes. However, it is possible to build delays upon delays that can exceed 10 minutes in total. This is non-compliant with EN54-2 Clause 7.11.1 c).
- It is recommended that any Input Group configured to apply delays to outputs (as defined in EN54-2 Clause 7.11), shall contain at least one MCP for the purposes of overriding any delay in order to comply with EN54-2 Clause 7.11.1 d).
- A panel can be configured to automatically silence and reset from the alarm condition. This is non-compliant with EN54-2 Clause 7.8 c).
- The time it takes to automatically reset from the alarm condition can be configured to be less than 5 minutes. This is non-compliant with EN54-2 Clause 7.12.2 d).
- It is possible for MCPs to be included in Dependencies A & B. This is non-compliant with EN54-2 Clauses 7.12.1 & 7.12.2.
- Setting the operation mode of an Input Group to '2 Devices' creates a double-knock scenario that could potentially make the panel non-compliant with EN54-2.
- Caution should be taken when programming any Action Sequence other than the 10 defaults provided, as it is possible to program an action that is non-compliant with EN54-2.
- When utilising Function Switches it is important to note that the CIE is driven by the event as opposed to the state. As a result, the use of multiple Function Switches to change the panel's mode of operation may result in some confusion if care is not taken to reset the state of the Function Switch(es).

9.1 Recommended Shortform Installation & Commissioning Procedure

Note: DO NOT connect Mains or battery power to the panel until the installation is complete, i.e. panel PCBs are fitted and field wiring has been tested and connected to the panel.

- Remove the panel's lid, chassis and PSU.
- Fit the panel's back box to a wall.
- Gland field cables to the panel and terminate all screens to the earth bar in the back box.
- Test field cables and ensure they are fault-free, i.e. check continuity of cable runs (including screens).
- Refit the panel's PSU.
- Connect external Mains cable to the panel (with Mains isolated) – see section 5.18.
- Connect panel's internal batteries (with battery supply isolated) – see section 5.19.
- Refit the panel's chassis and lid.
- Connect analogue loop(s) wiring to the panel – see section 5.11.
- Connect conventional sounder circuit(s) to the panel – see section 5.12.
- Connect additional field wiring to the panel – see sections 5.13 to 5.15.
- Apply Mains and battery supply to power up the panel.
- Investigate and rectify any messages reported as faults on the panel's touchscreen.

The panel is now ready to be programmed.

- Carry out a loop learn, as detailed in section 9.5.1, and rectify any problems resulting from the loop learn.
- When all faults have been cleared, proceed to program the panel as appropriate.
- When you are satisfied the panel has been programmed and is working correctly, secure the panel lid and instruct the client / customer in the operation of the system.
- Complete and hand over all necessary manuals and other documentation prior to leaving site.



Hint: ZFP Programming Software (Part No. ZTOOLS) are available that allow quick and easy input of data, cause and effect programming, device and zone naming, etc. Contact your distributor for details.

Figure 19 – Access Level 3 Menu Structure

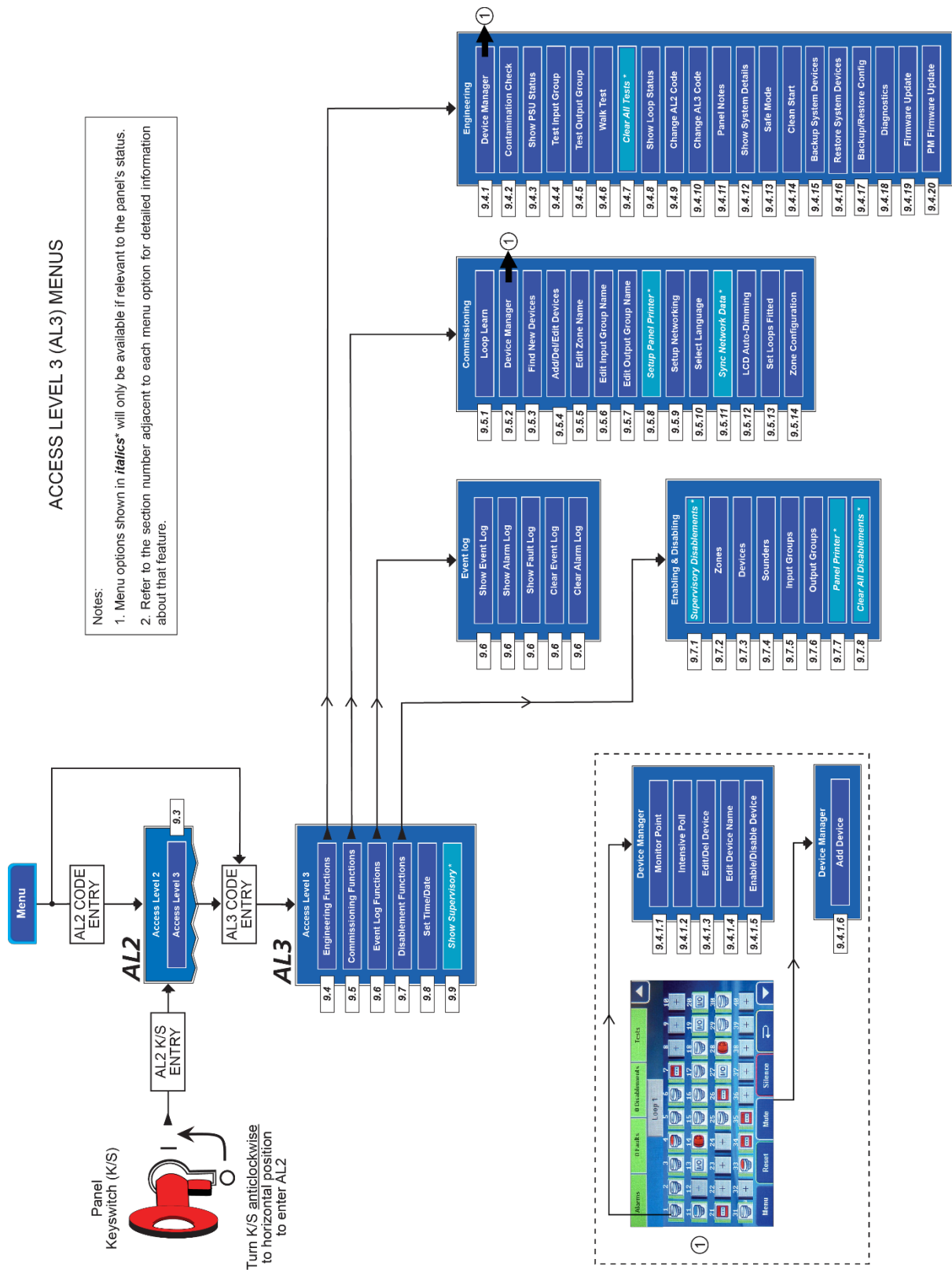

9.2 Access Level 3 Menu Structure

Figure 19 shows the menu options available at access level 3.

Three 'access levels' are available at the panel; general user (access level 1), authorised user (access level 2) and authorised systems engineer (access level 3). This manual focuses on the programming functions available at access level 3 only; access levels 1 & 2 are covered in the separate User Manual (DFU5000501), including information on how fire, fault, disablements and test conditions are reported and dealt with.

At access level 3, you can:

- View any active fires, faults, disablements or test conditions that are displayed on the touchscreen.
- Gain entry to the panel's access level 2 menu options.
- Gain access to a wide range of engineering functions (see section 9.4) and commissioning functions (see section 9.5).
- View and reset the panel's alarm counter.
- Display, filter, print or clear the panel's event log (see section 9.6).
- Enable or disable zones, sounders, Input Groups, Output Groups and loop devices (see section 9.7).
- Set the panel's time and date (see section 9.8).

9.3 How to Enter Access Level 3 (AL3)

- **Entry to AL3 using the panel's touchscreen**

With the panel operating under normal conditions (shown below left), press the **Menu** button on the panel's touchscreen to show the access level 1 menu options (shown below right).

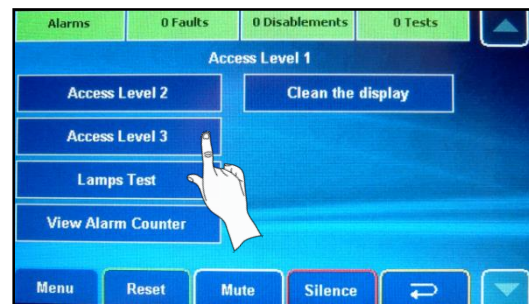

Press the **Access Level 3** button and the display shown below left appears.

Using the touchscreen's numeric keypad, enter the four-digit access level 3 code. The default code is: **4 4 4 4**.

When the code has been entered correctly, the access level 3 menu options are displayed (shown below right). Note that the panel will automatically exit access level 3 after 20 minutes without a button press.

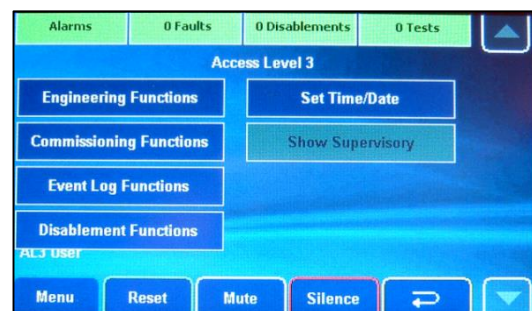
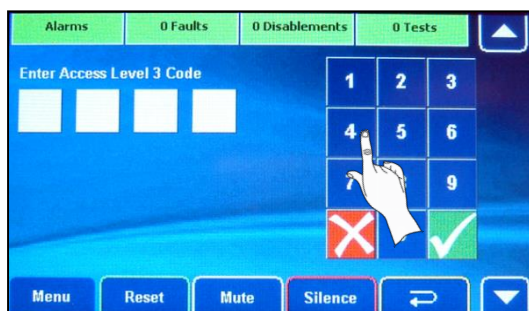

- **Entry to AL3 using the panel's keyswitch and touchscreen**

With the panel operating under normal conditions, turn the panel's keyswitch anticlockwise to the horizontal position to display the access level 2 menu options. As detailed above, press the **Access Level 3** button and input the four-digit access level 3 code.

9.4 Engineering Functions

The Engineering Functions menu is used to access the panel’s comprehensive test functions and display important system status information.

At Access Level 3, press the  button and the window shown below left appears.

Scroll down  to view additional engineering menu options (shown below centre and right).



Engineering functions are listed in sections 9.4.1 to 9.4.20.

9.4.1 Device Manager

Using this function you can display, edit and test all the addressable devices stored in the panel’s memory which include loop devices, system devices and A-Bus devices.

At Access Level 3 > Engineering Functions, press the  button and a window similar to the one shown below appears.

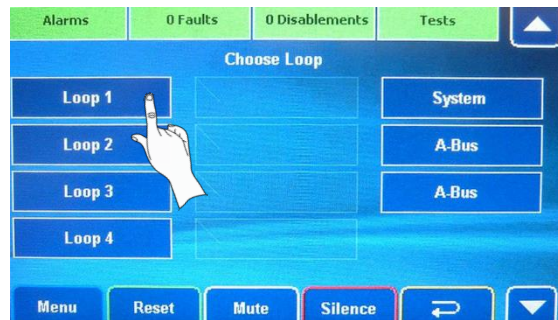

Loop 1 is shown selected as an example.

Loop Number Field (Loop 1 shown selected)

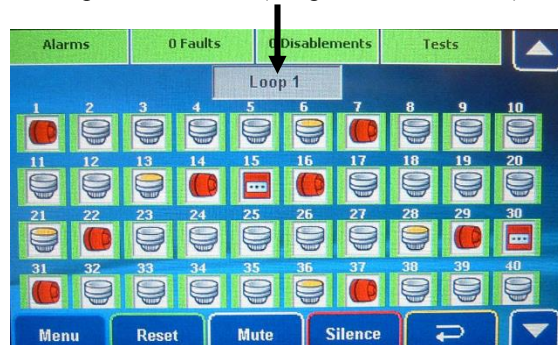

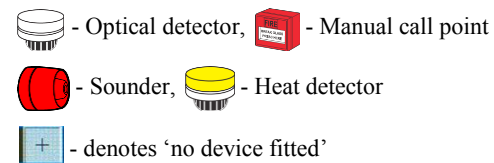

Loop Devices window:

- displays loop addresses (up to 126 devices per loop)
- displays loop device icons, examples shown below:

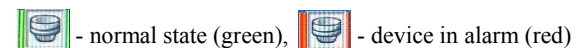

Note the background colour of a device icon changes to reflect its status. Green is normal, red is alarm state, yellow is fault state. See examples shown below:



To view all the devices on the loop, press anywhere in the Loop Devices window and use the  and  buttons to scroll through all the devices.

ZFP Networkable Analogue Addressable Fire Alarm Panel

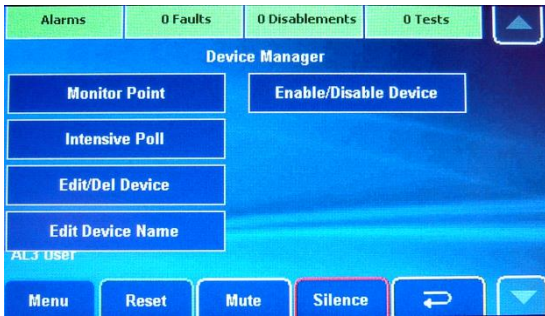

When an individual loop device icon is pressed another window appears (shown left) allowing the user to perform additional functions, which are listed below.

9.4.1.1 Monitor a Point

This function allows you to view the current analogue status of a specific addressable point on a loop. During this test, the panel temporarily disables the point being monitored from reporting fires, pre-alarms and faults. Therefore, use this function with care.

Press the **Monitor Point** button to start the test and a typical display (shown below left) appears showing the analogue values. Press this button and a typical display (shown below right) appears. Note this display will differ for different devices (detectors, sounders, I/O units, etc.). In the example shown, select 'Remote LED', 'Fire LED' or 'Test'.

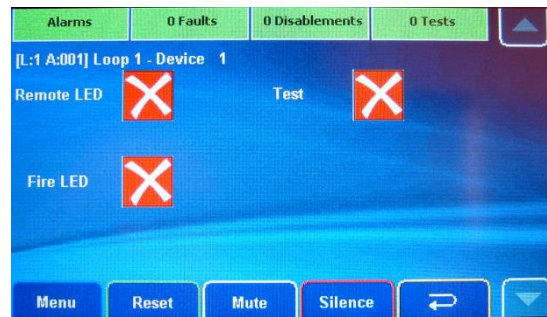

The test will start and the panel returns back its analogue values on the touchscreen.

9.4.1.2 Intensive Poll

This function allows you to monitor a specific addressable point on the system to see how it responds to intensive, repeated polls from the panel. During this test, the panel temporarily disables the point being monitored and also the panel from reporting fires, pre-alarms and faults. Therefore, use this function with care.

Press the **Intensive Poll** button to start the test and a typical display (shown below left) appears showing the polling results. Press this button and a typical display (shown below right) appears. Note this display will differ for different devices (detectors, sounders, I/O units, etc.). In the example shown, select 'Remote LED', 'Fire LED' or 'Test'.

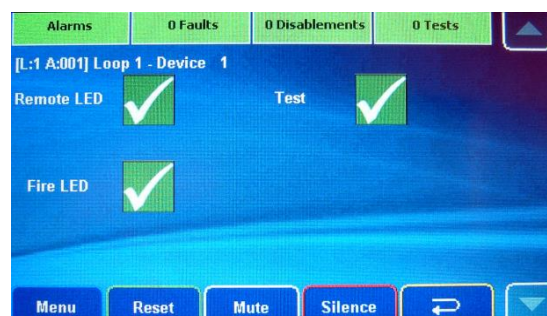

The test will then start. As the device is intensively polled, some of its analogue values may change, helping to assist you to pinpoint loop wiring / communication faults and/or faulty devices. The running total of the number of good and bad polls between the panel and monitored device at any time appears in the top right corner of the display, e.g. '72' (denotes good poll) / '0' (denotes bad poll).

9.4.1.3 Edit/Delete Device



This function allows a selected device's parameters to be edited including:

- Device type
- Zone
- Input or Output Group
- Device name.

9.4.1.4 Edit Device Name



This function allows the text description assigned to specific devices to be created, or amended.

When selected, use the touchscreen's Qwerty keyboard to change the text description.

9.4.1.5 Enable/Disable Device

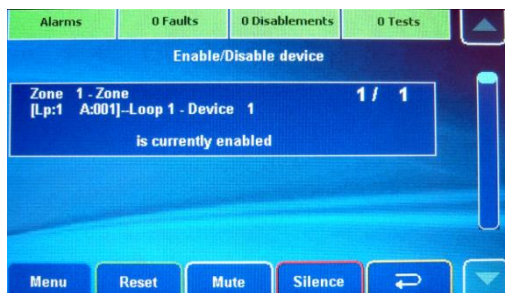



This function allows the state of a specific device to be toggled between 'enabled' and 'disabled' state.

9.4.1.6 Add Device



This function allows devices to be added to a loop.

In the Loop Devices window (shown in section 9.4.1), press a 'no device fitted' icon  and the display shown left appears.

Press the  button and the display shown in section 9.4.1.3 appears allowing the device's parameters to be added.

9.4.2 Contamination Check



This function checks all detection devices on a loop for contamination.

When selected the display shown left is displayed showing the default minimum and maximum analogue values (AV).

Select which loop(s) to test and press the  button to start the contamination check.

After the check is completed, any detection devices that fall outside of the analogue range (below the Min AV, or above the Max AV) will be listed on the touchscreen.

9.4.3 Show PSU Status

This function allows you to view important information regarding the state of the panel's PSU and its standby battery supply.

9.4.4 Test Input Group

This function allows you to perform tests on the panel's Input Groups, e.g. simulate a manual call point input to the panel to test the cause and effects.

At Access Level 3 > Engineering Functions, press the  button and choose the Input Group to be tested from the list of available groups. In the next window choose the type of test to be performed on the Input Group including: NORM or TRIG test.



9.4.5 Test Output Group

This function allows you to perform tests on the panel's Output Groups.

At Access Level 3 > Engineering Functions, press the  button and choose the Output Group to be tested from the list of available groups. In the next window choose the type of test to be performed on the Output Group including: OFF, ON and PULSED test.

9.4.6 Walk Test

This function allows you to put one or more of the system's detection zones into walk test mode. When a zone is in walk test mode, any detector / manual call point triggered on that zone will turn on all of the sounders that are assigned to that zone for a brief period.

At Access Level 3 > Engineering Functions, press the  button and in the next window choose the type of test to be performed, e.g. Sounders Enabled, Turn LED ON when in Fire, etc. After making a selection, press the  button and in the next window select the zone(s) you wish to put into walk test mode by pressing the zone button(s). This toggles the zone's state between NORMAL operation and ON TEST.

Any zones in test can be viewed by pressing the yellow  button on the top line of the touchscreen. Any devices not tested will be listed on the touchscreen.

9.4.7 Clear All Tests

This function globally clears all active tests on the system. The button is greyed out when there are no tests on the system.

9.4.8 Show Loop Status

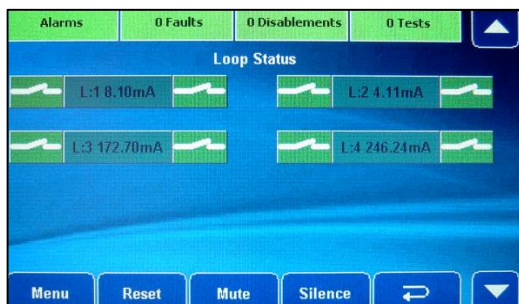

This function allows you to view the level of electrical current being drawn by the addressable loop(s) and check the loop isolator condition.

At Access Level 3 > Engineering Functions, press the  button and a window similar to the one shown left appears.

If there is a fault on one of the loops the background colour of the switch will change from green to yellow.

The actual loop current drawn will depend upon the number of devices connected on a loop.

9.4.9 Change Access Level 2 (AL2) Code

This function is used to change the four-digit code needed to enter the panel's access level 2 menu options.

At Access Level 3 > Engineering Functions, press the **Change AL2 Code** button and the window shown below appears:



Use the touchscreen's numeric keypad buttons to enter the new access level 2 code. After the fourth digit has been entered, the panel will request you confirm the new code by re-entering it.

Enter the code again by pressing the buttons in the same sequence. If the two codes match, the panel will accept the code and you will be taken back to the engineering menus. If you type an incorrect confirmation code you will be prompted to start the new code entry sequence again.

9.4.10 Change Access Level 3 (AL3) Code

This function is used to change the four-digit code needed to enter the panel's access level 3 menu options.

At Access Level 3 > Engineering Functions, press the **Change AL3 Code** button and the window shown below appears:



Use the touchscreen's numeric keypad buttons to enter the new access level 3 code. After the fourth digit has been entered, the panel will request you confirm the new code by re-entering it.

Enter the code again by pressing the buttons in the same sequence. If the two codes match, the panel will accept the code and you will be taken back to the engineering menus. If you type an incorrect confirmation code you will be prompted to start the new code entry sequence again.

9.4.11 Panel Notes

This function allows panel specific comments to be written by an authorised systems engineer. These comments are editable.

When selected, press anywhere in the Comments window (shown below left) and in the next window that appears use the touchscreen's Qwerty keyboard to add pertinent notes about the panel (shown below right).

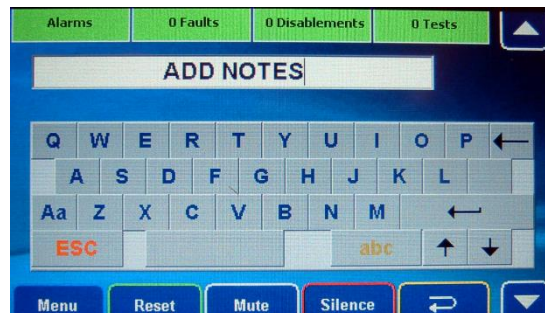
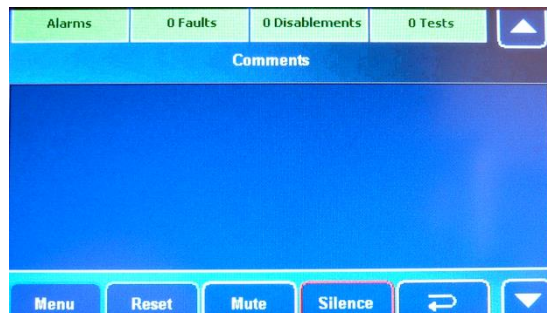

9.4.12 Show System Details

This function lists system details including the panel's firmware version number and internal SD memory card information.

9.4.13 Safe Mode

This function disables all of the panel outputs whilst tests are being performed on the system. When selected you will be asked to enter the five-digit safe mode password.



CAUTION: This function is for trained engineers only. Contact C-TEC Technical Support to obtain a valid access code.

9.4.14 Clean Start

This function allows you to clear the panel's memory back to its factory default settings. When selected, you will be asked to enter the five-digit security code. The default code is: **3 2 7 6 7**.

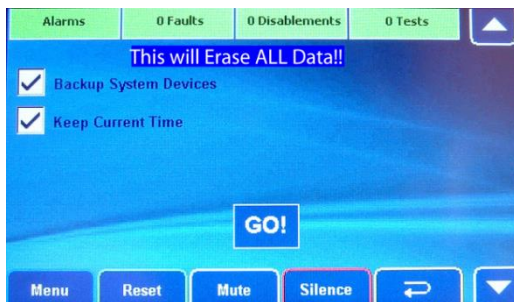

CAUTION: This function is for trained engineers only. Performing a clean start **COMPLETELY ERASES** the panel's memory (held on the internal SD memory card).

9.4.15 Backup System Devices

This function saves the panel's system devices to the internal SD memory card.

9.4.16 Restore System Devices

This function retrieves the panel's system devices from the internal SD memory card.

9.4.17 Backup/Restore Config

This function saves / retrieves the panel's entire Config settings to / from the internal SD memory card.

9.4.18 Diagnostics

These functions are for trained engineers only and is not detailed in this manual.

9.4.19 Firmware Update

This function allows the panel to appear as a removable drive on a PC and can be used for re-flashing the ZFP firmware using the internal SD card. Please refer to Document No. DFU5000507 for further details.

9.4.20 PM Firmware Update

The PM (Peripheral Module) function updates the loop driver firmware. Contact C-TEC Technical Support to obtain a valid access code.

9.5 Commissioning Functions

The Commissioning Functions menu is used to carry out numerous commissioning tasks including, a loop learn, view fitted devices, assign detectors / call points to Input Groups and sounders/beacons to Output Groups.



Hint: ZFP Programming Tools (Part No. ZTOOLS) are available that allow quick and easy input of data, cause and effect programming, device and zone naming, etc. Contact your distributor for details.

At Access Level 3, press the **Commissioning Functions** button and the window shown below left appears.

Scroll down  to view additional commissioning menu options (shown below right).

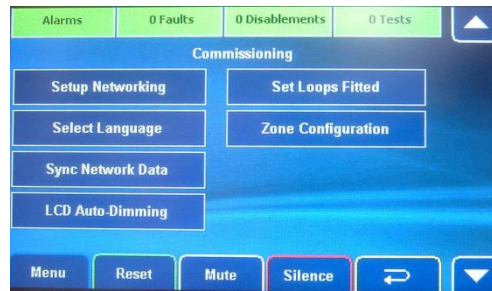

Commissioning functions are listed in sections 9.5.1 to 9.5.14.

9.5.1 Loop Learn

During a loop learn, the panel interrogates every device fitted on a selected loop to identify their address and to find out the type of device. This provides the opportunity to identify any missing devices, double-addressed devices, incomplete loops as well as wrong device types.

At Access Level 3 > Commissioning Functions, press the **Loop Learn** button and the window shown below appears.

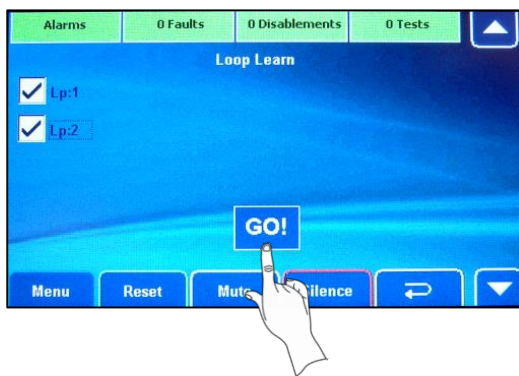

Select the loop(s) you want the panel to learn (Loop 1 and Loop 2 are shown selected left), then press the **GO!** button. A progress bar will be shown during the loop learn process. Depending on the size of the installation, the loop learn process can take several minutes.

AFTER A SUCCESSFUL LOOP LEARN YOU WILL HAVE A SINGLE ACTIVE ZONE (I.E. ZONE 1) “ONE OUT, ALL OUT” FIRE ALARM SYSTEM!



Note that by default the loop learn will assign all detectors, manual call points and inputs of I/O units to Input Group 1 and all sounders, beacons and outputs of I/O units to Output Group 1. This is to ensure that all of the system's sounders will activate in the event of a fire condition anywhere in the building, i.e. one out, all out. No special cause and effects events are assigned. These default settings can be modified as appropriate using the panel's PC Tools at a later date.

9.5.2 Device Manager

At Access Level 3 > Commissioning Functions, press the **Device Manager** button.
Refer to Device Manager section 9.4.1 for details.

9.5.3 Find New Devices



This function is similar to performing a loop learn and enables new devices (or changed devices) installed on a loop to be detected by the panel and then programmed.

9.5.4 Add/Delete/Edit a Device



Refer to Device Manager section 9.4.1.3 for details.

9.5.5 Edit Zone Name

This function allows a text description to be assigned to a zone.

At Access Level 3 > Commissioning Functions, press the **Edit Zone Name** button and a window similar to the one shown below left appears.

To change a zone's text description, press the text description button ('Zone 1' is shown as an example) and the window shown below right appears. Amend the text using the touchscreen's standard Qwerty keyboard controls.

To select a different zone for editing, either press the zone number field (001 shown below left) and use the  and  buttons to scroll through the zones, or enter the zone number directly into the zone number field using the touchscreen's numeric keypad.



9.5.6 Edit Input Group Name

This function allows text descriptions for Input Groups to be changed.

At Access Level 3 > Commissioning Functions, press the **Edit Input Group Name** button and a window similar to the one shown below appears.



Amend the text descriptions by following the same operating procedure detailed in section 9.5.5.

9.5.7 Edit Output Group Name

This function allows text descriptions for Output Groups to be changed.

At Access Level 3 > Commissioning Functions, press the **Edit Output Group Name** button and a window similar to the one shown below appears.



Amend the text descriptions by following the same operating procedure detailed in section 9.5.5.

9.5.8 Setup Panel Printer

This function is used to set various printing options if an integrated panel printer is fitted, including print alarms, print faults, etc.

9.5.9 Setup Networking

This function is used to assign network ID addresses to Segments.

Refer to networking section 6.6 for details.

9.5.10 Select Language

This function changes the text language of the touchscreen buttons and menus. The default language is English.

9.5.11 Synchronise Network Data

This function synchronises data held by various panels connected on a networked system, including loop numbers, loop addresses, device types, zones, Input Groups and Output Groups.



Using this function, updated files are copied from panel to panel with the purpose of keeping the data held by each panel identical. If the system is not working correctly, this function can be used for troubleshooting purposes.

9.5.12 LCD Auto-Dimming

This function adjusts the touchscreen's power save mode.

At Access Level 3 > Commissioning Functions, press the **LCD Auto-Dimming** button and the window shown below appears.



By default, the LCD backlight will switch off after 60 seconds. To select a different dimming time press the 'Secs' field (060 shown left) and use the  and  buttons to adjust the time, or enter the time directly into the field using the touchscreen's numeric keypad.

Enter '0' to disable power save mode.

9.5.13 Set Loops Fitted

This function sets the number of loops the panel's firmware assigns to a panel. Note that the actual physical number of loops that can be connected to a panel is dependent on the number of loop driver modules fitted, i.e. Main 1-Loop PCB, Main 2-Loop PCB, 2-Loop PCB, etc.

9.5.14 Zone Configuration

If this option is ticked then the alarm sounders will resound if a new fire alarm condition occurs in the same zone. This function is not set (ticked) by default.

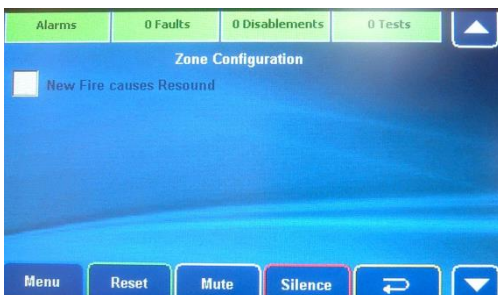

Important Note: Setting this function will make the panel non-compliant with the requirements of EN54-2.

9.6 Event Log Functions

This function lists, filters and resets the panel's event, alarm or fault log. Also, a hard copy of each log may be printed using the integrated printer (if fitted).

At Access Level 3, press the  button and the window shown below appears:



The **Show Event Log** button, when pressed, lists both the panel's event and alarm log (up to 20,000 events). This includes fire, fault and system events.



The **Show Alarm Log** button, when pressed, lists only the panel's alarm log. Typically, alarm events include activated fire alarms, panel silenced and panel reset.

The **Show Fault Log** button, when pressed, lists the panel's fault log. Typically, faults include missing devices, earth faults, open/short circuit faults and watchdog resets.

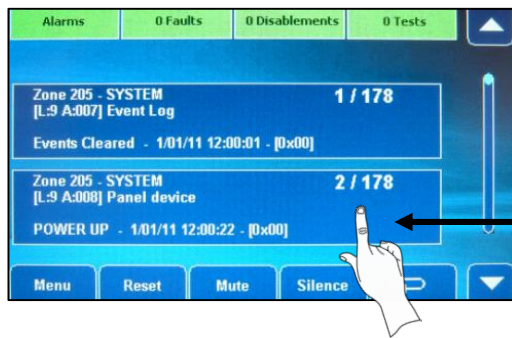
The **Clear Event Log** and **Clear Alarm Log** buttons, when pressed, clears the respective log from the panel's memory. To ensure a log is not erased by mistake, a five-digit security code requires entering using the touchscreen's numeric keypad. The default code is: **3 2 7 6 7**.



The window shown left is a typical list of saved events.

Press the  and  buttons (or use the scroll bar) to scroll through the list. Events are listed in chronological order with the most recent listed last. When the log is full, the oldest record is deleted and replaced by the newest record.

Event log button
(displays both panel events and alarms)

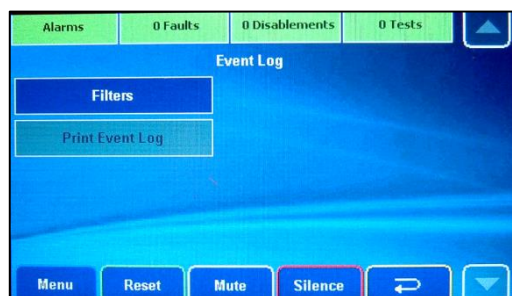

To either filter, or print, the log, press one of the blue event log buttons and the window shown left appears.

The **Filters** button, when pressed, allows events to be listed by Date Range or Device Address.

The **Print Event Log** button, when pressed, allows you to print a hard copy of the panel's log to the integrated printer (if fitted).

9.7 Disablement Functions

This function allows you to enable, or disable, parts of the system including zones, individual devices, sounders, Input Groups, Output Groups and the panel’s integrated printer (if fitted).

Remember, any active disablement(s) can be viewed (and cleared) at any access level by pressing the yellow **n Disablements** button on the top line of the touchscreen.

Note: It is strongly recommended all disablements are regularly reviewed and immediately cleared when no longer necessary as they can have a major effect on how the system works.

At Access Level 3, press the **Disablement Functions** button and a window similar to the one shown below will appear.





Note: If a function is unavailable it will be ‘greyed’ out, e.g. the **Panel Printer** button.

9.7.1 Supervisory Disablements

This function is only available when there are hidden ‘supervisory’ disablements on the system, which are programmed by an authorised systems engineer. Supervisory functions include non-fire, non-fault related events, e.g. class change, gas shut off valve operated, emergency lighting system signals, etc.

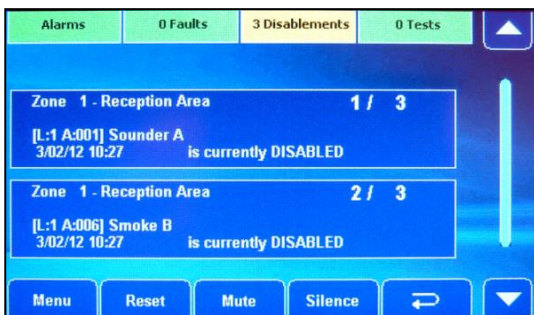
At Access Level 3 > Disablement Functions, press the **Supervisory Disablements** button and a window similar to the one shown below will appear detailing the type and location of the disablement. **Note:** The total number(n) of disablements is also shown on the yellow **n Disablements** button (‘3’ shown in example below).



If there are more than one disablement, the top right corner of the window will show, for example “1 / 3” and can be scrolled through using the  and  buttons, or by using the scroll bar.

To cancel a specific disablement, press the individual blue disablement button (Disabled Sounder A located in Zone 1 – Reception Area is shown in the example). A small **Cancel Disablement?** button appears (shown below). Press this button to confirm the cancellation.

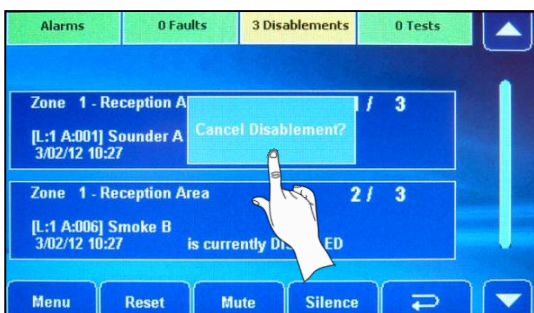

9.7.2 Enable/Disable Zones

This function allows you to disable (and re-enable) all zones or selected zones, from reporting fires, faults, pre-alarms, etc., and is normally used to temporarily disable detectors, including manual call points, in a selected zone. For example, in areas where work is being carried out that could trigger an erroneous fire alarm.

At Access Level 3 > Disablement Functions, press the **Zones** button and a window similar to the one shown below left will appear.



Press the **▲** and **▼** buttons (or use the scroll bar) to scroll the display through all available zones. Toggle a selected zone's enabled/disabled state by pressing the individual zone button (Zone 1 status is changed from enabled to disabled in the example above). After changing a zone's status, press the **↶** button to escape.

9.7.3 Enable/Disable Devices

This function allows system devices to be disabled (and re-enabled) from reporting fires, faults, pre-alarms, etc., and is normally used to temporarily disable detectors/manual call points that are nuisance tripping.

At Access Level 3 > Disablement Functions, press the **Devices** button and the window shown below will appear:



Press the **By Zone** button to select and disable all devices within a specific zone, or press the **By Address** button to select and disable individual devices by entering their loop number and address.

Follow the same operating procedure previously listed in section 9.7.2.

9.7.4 Enable/Disable Sounders

This function is used to disable (and re-enable) one or more sounders from sounding in a fire condition. **Note:** Sounders include the panel's conventional sounders (powered from the panel) and loop sounders (loop powered) and form part of an Output Group, which are programmed by an authorised systems engineer.

At Access Level 3 > Disablement Functions, press the **Sounders** button and follow the same operating procedure previously listed in section 9.7.2.

9.7.5 Enable/Disable Input Groups

This function is used to disable (and re-enable) one or more Input Groups from activating. **Note:** Input Groups comprise of detectors, MCPs, inputs of I/O units, keyswitches and other input devices and are programmed by an authorised systems engineer.

At Access Level 3 > Disablement Functions, press the **Input Groups** button and follow the same operating procedure previously listed in section 9.7.2.

9.7.6 Enable/Disable Output Groups

This function is used to disable (and re-enable) one or more Output Groups from activating. **Note:** Output Groups comprise of loop and conventional panel sounders, beacons, outputs of I/O units, relays and other output devices and are programmed by an authorised systems engineer. This function is typically used to disable, for example, auto-diallers and other ancillary equipment from activating during routine maintenance.

At Access Level 3 > Disablement Functions, press the  button and follow the same operating procedure previously listed in section 9.7.2.

9.7.7 Enable/Disable Panel Printer

This function is used to disable (and re-enable) the integrated panel printer (if fitted).

At Access Level 3 > Disablement Functions, press the  button and follow the same operating procedure previously listed in section 9.7.2.

9.7.8 Clear All Disablements

This function is used to globally clear all current disablements on the system.



At Access Level 3 > Disablement Functions, press the  button and follow the same operating procedure previously listed in section 9.7.2.

9.8 Set the Panel's Time and Date

This function is used to set the panel's time and date, which is required for accurate logging of events in the panel's log. The panel has a real-time 24 hour clock with default time and date settings. An automatic DST (Daylight Saving Time) option is available which will automatically adjust the panel's clock one hour forward on the last Sunday in March and one hour backward on the last Sunday in October.

At Access Level 3, press the  button and a window similar to the one shown below appears.



Adjust the time and date using the touchscreen's numeric keypad and   buttons. Also, set/unset the daylight saving time by pressing the **DST** tick box.

When correct, press the  button to return to the main access level 3 menus.

9.9 Show Supervisory Events

This function is only available if relevant to the panel's status, i.e. if access level 3 supervisory events have been programmed by an authorised systems engineer.

At Access Level 3, press the  button. The display shows all access level 3 non-fire, non-fault related events, e.g. class change, gas shut off valve operated, panel keyswitch activated, emergency lighting system signals, etc.

10 MAINTENANCE

Periodic/routine maintenance should be carried out in accordance with all applicable national, regional or local regulations, standards and working practices. Maintenance of equipment external to the control panel will be detailed in the appropriate manufacturer's literature. The following is recommended as a guideline only.

Daily (Authorised User Responsibility)

- ✓ Check the panel's indicators and touchscreen indicate normal operation and no faults are present on the system.
- ✓ Ensure the Fire Alarm Log Book is kept up to date by recording fire signals, fault signals, work on the system, etc.

Monthly (Authorised User Responsibility)

- ✓ At least one manual call point or detector (from different zones each month) should be operated to test the fire panel and any connected alarm/warning devices. This operation should be carried out on a rotating basis, so that all devices are checked at least once over a period of 3 months.
- ✓ Where permissible, any link to the fire brigade or remote manned centre should be operated.
- ✓ Any defects should be recorded in the Fire Alarm Log Book and reported to the maintenance provider.

Quarterly (Authorised Service Personnel Responsibility)

- ✓ Check entries in the Fire Alarm Log Book and inspect the panel's event log, taking appropriate corrective action where necessary.
- ✓ Check the alarm, fault and ancillary functions of the panel.
- ✓ Visually inspect the exterior of the enclosure for any signs of damage or loose cable glands and rectify any faults found. Inspect the panel interior for any moisture ingress or other deterioration. Examine the printed circuit boards for signs of over-heating or damaged tracks. Replace any defective items.
- ✓ Enquire if any structural alterations have been made which could affect the operation of call points, detectors or sounders, if so carry out a visual inspection.
- ✓ Any defects should be recorded in the Fire Alarm Log Book and corrective action taken.

Yearly (Authorised Service Personnel Responsibility)

- ✓ Carry out the recommended daily, monthly and quarterly maintenance schedules.
- ✓ 'Walk Test' the system and check that each detector operates in accordance with the manufacturer's recommendations.
- ✓ Visually inspect all cable fittings and ensure equipment is secure, undamaged and adequately protected.
- ✓ Examine the panel's standby batteries for integrity of the connections, signs of corrosion. Perform a periodic load test with the Mains supply disabled to ensure adequate battery capacity. The batteries are maintenance free and therefore should only be replaced if there is any doubt about their integrity.



CAUTION: There is a risk of explosion if an incorrect battery type is used. Always dispose of used batteries in accordance with the battery manufacturers' instructions.

- ✓ Any defects should be recorded in the Fire Alarm Log Book and corrective action taken.

Appendix 1 – Enclosure Dimensions and Fixing Details

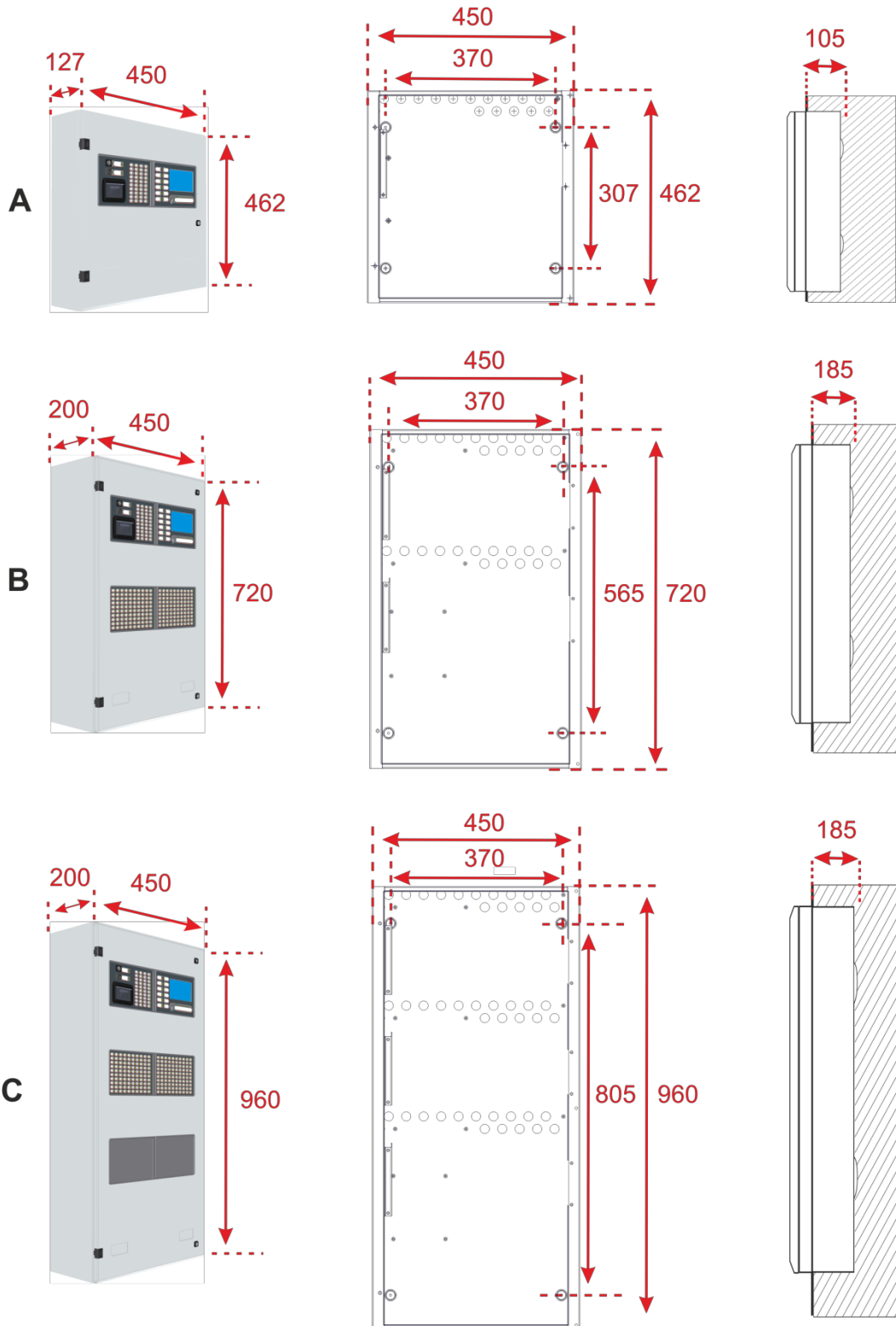

All dimensions in mm. Drawings not to scale.

A	Standard Shallow Enclosure. 1, 2 or 4 loops (fits up to 2 x 18Ah batteries). Part No. ZBOXS.
B	Medium Deep Enclosure. 1, 2, 4, 6 or 8 loops (fits up to 2 x 38Ah batteries). Part No. ZBOXM.
C	Large Deep Enclosure. 1, 2, 4, 6 or 8 loops (fits up to 2 x 38Ah batteries). Part No. ZBOXL.

ZFP Networkable Analogue Addressable Fire Alarm Panel

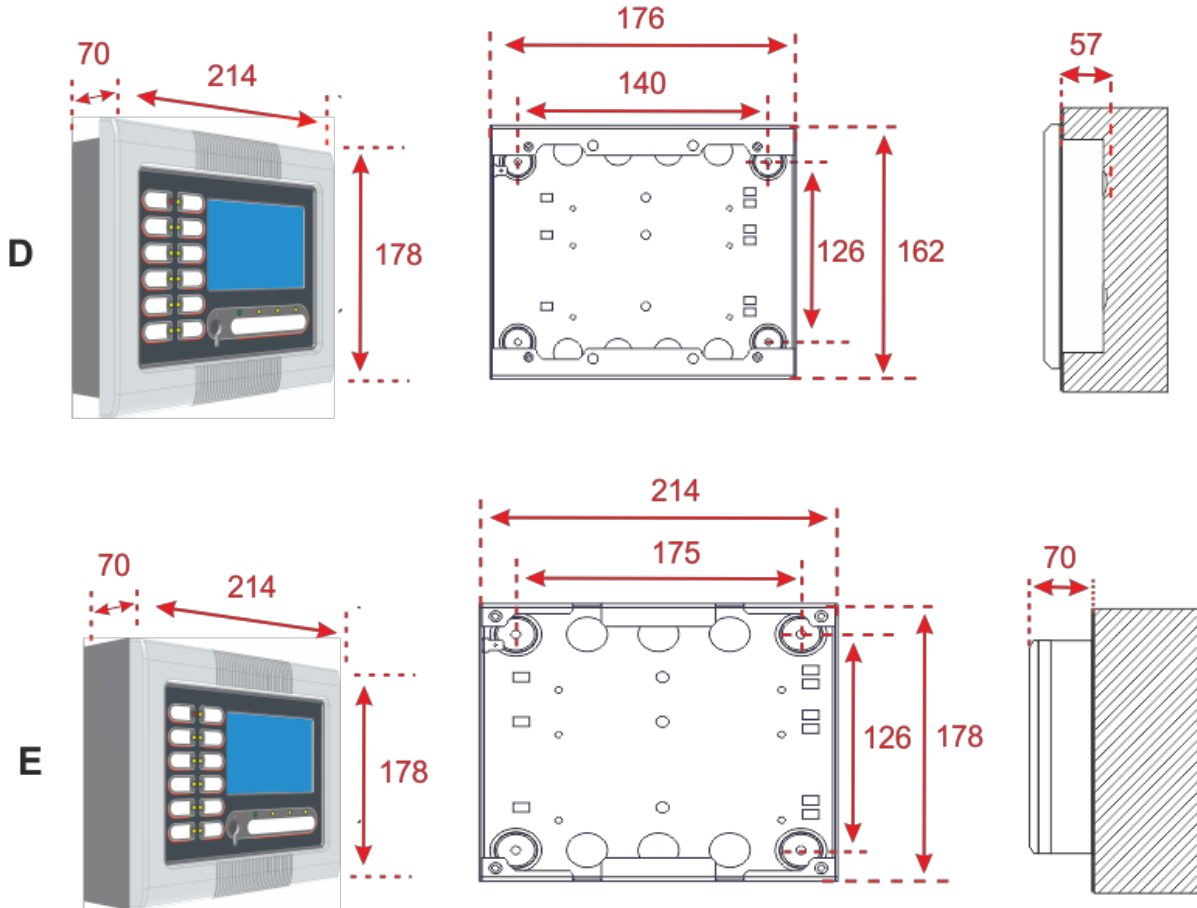

All dimensions in mm. Drawings not to scale.

D	Compact Controller – Flush Mount. c/w 'Hi-NET' network PCB (Part No. ZREP1F).
E	Compact Controller – Surface Mount. c/w 'Hi-NET' network PCB (Part No. ZREP1S).

Appendix 2 – Bezels (Flush-Mount)

Three bezel sizes are available for the ZFP range of panels allowing the panels to be flush-mounted on a wall.

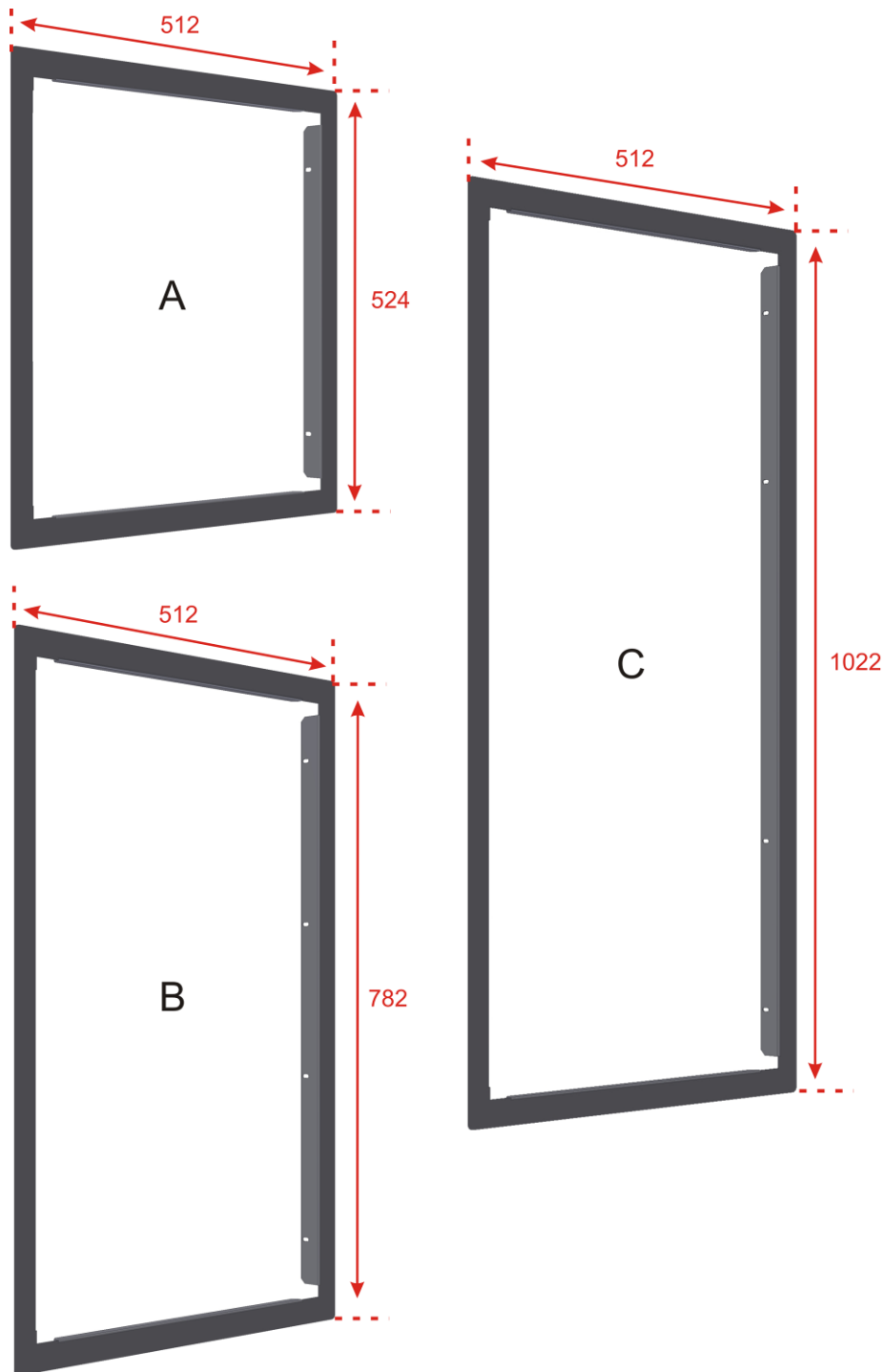

All dimensions in mm.

A	Standard Flush-Fit Bezel. Depth 30mm, Thickness 1.2mm. Part No. ZBEZS.
B	Medium Flush-Fit Bezel. Depth 30mm, Thickness 1.2mm. Part No. ZBEZM.
C	Large Flush-Fit Bezel. Depth 30mm, Thickness 1.2mm. Part No. ZBEZL.

Appendix 3 – Chassis

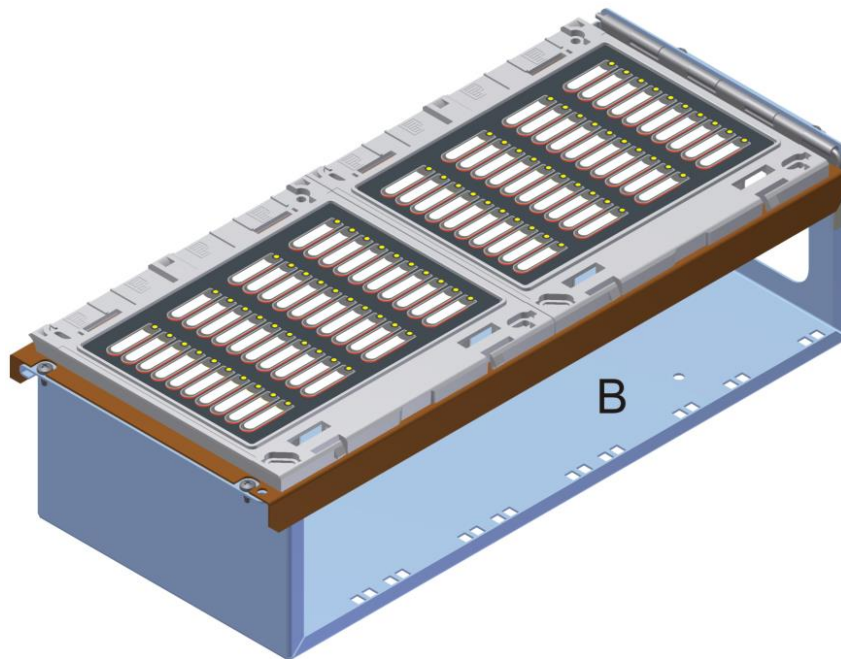
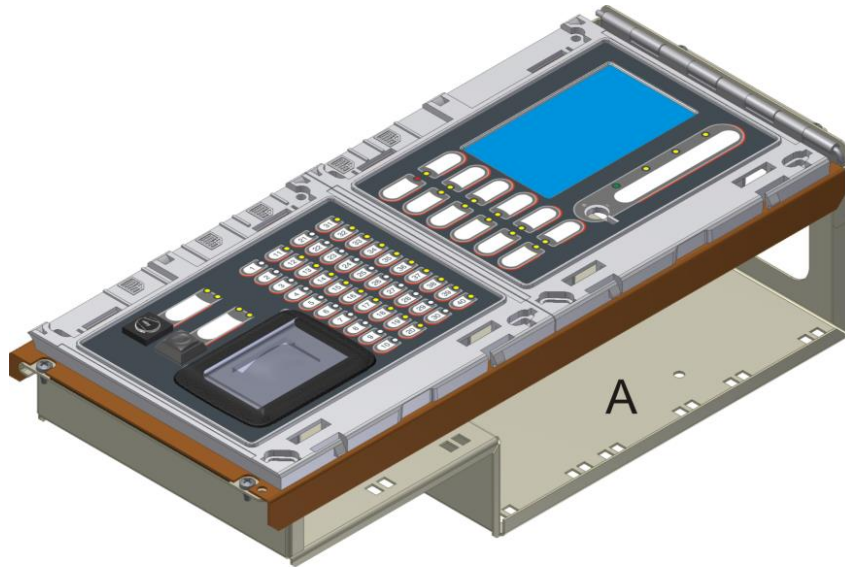

All dimensions in mm

A	Stepped Chassis. Part No. ZCHA1
B	Flat Chassis. Part No. ZCHA2

Appendix 4 – List of Modules

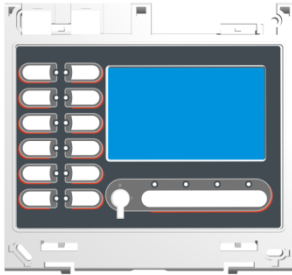

Control/Display module
c/w 4.3" touchscreen,
keyswitch, 16 LEDs
- Part No. Z41

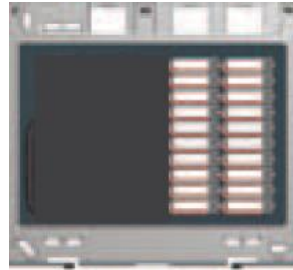

20 zone indicator
module c/w name slots
- Part No. Z44

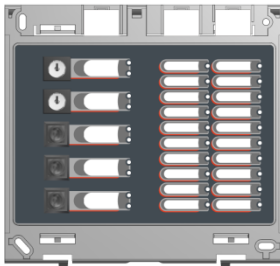

20 zone indicator
module c/w name slots,
5 switches, 10 bi-colour
function LEDs
- Part No. Z45

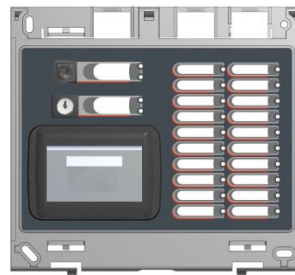

20 zone indicator
module c/w name slots,
printer, 2 switches, 4 bi-
colour function LEDs
- Part No. Z46

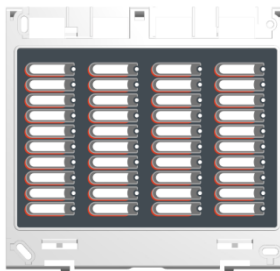

40 zone indicator
module c/w name slots
- Part No. Z47

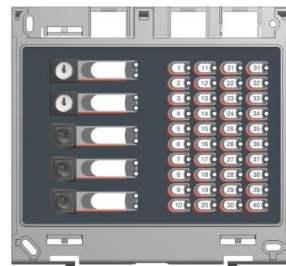

40 zone indicator
module c/w 5 switches,
10 bi-colour function
LEDs
- Part No. Z48



40 zone indicator
module c/w printer, 2
switches, 4 bi-colour
function LEDs
- Part No. Z49

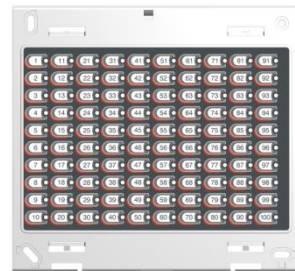

100 zone indicator
module (numbered 1-
100)
- Part No. Z50/1-100

100 zone indicator
module (numbered 101-
200)
- Part No. Z50/101-200

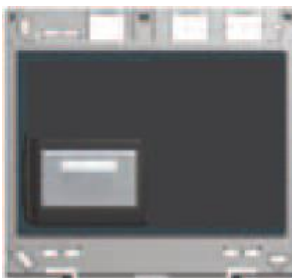

Printer module
- Part No. Z51



Blank module
- Part No. ZBLANK

Appendix 5 – Standby Battery Calculation Guide

The standby time of the fire alarm panel, after the Mains has failed, depends on the quiescent and alarm loading of the panel, and the capacity of the batteries. To determine the capacity of batteries required for any given stand-by period, the following formula should be used:

$$\text{Battery Capacity in Ah} = 1.25 \times \underbrace{[(T \times (A + L \times 1.5))]}_{\text{Alarm Capacity}} + \underbrace{[H \times (P + Z \times 1.5)]}_{\text{Quiescent Capacity}}$$

The multiplier 1.25 is present to account for lost capacity over the life of the batteries.

H = Number of hours standby required (e.g. 24Hrs).

P = Quiescent current of the panel. 4 loop panel = 120mA (0.12A); 8 loop panel = 220mA (0.22A).

This value is with the Mains failed, beeper silenced and the Supply Present and General Fault indicators lit. If there are other quiescent drains on the panel then these must be added in.

Z = Total quiescent current of all loop devices

As a guideline, the total quiescent current of all Discovery addressable devices for a 4 loop panel and 8 loop panel, with 80 devices per loop, is typically 136mA (0.136A) and 272mA (0.272A) respectively.

To obtain accurate values consult the device manufacturers' own specifications.

A = Total alarm current of panel sounders and activated relays. Conventional sounder load is 250mA (0.25A), a panel relay consumes 20mA (0.02A) when activated.

L = Total alarm current of loop devices per loop (sounders, beacons etc.) is typically 150mA (0.15A).

T = Amount of time in hours required for the alarm (e.g. half an hour, 0.5Hrs).

Example calculation for a 4 loop panel:

The 4 loop panel has 80 Discovery devices per loop (320 in total) with a total quiescent current of 136mA (0.136A) for all loop devices. In alarm, the alarm current per loop is 0.15A (0.6A in total), 2 panel relays activated at (0.02A each), and a conventional sounder load of 0.25A. The required standby time is 24 hours, and the required alarm time is 0.5 hours.

Calculate the alarm capacity: $= T \times (A + L \times 1.5)$

$T = 0.5\text{Hrs}; A = 0.25 + 2 \times 0.02 = 0.29\text{A}; L = 0.15 \times 4 = 0.6\text{A}$

Therefore, the alarm capacity is: $= 0.5 \times (0.29 + 0.6 \times 1.5)$
 $= 0.595\text{Ah}$

Calculate the quiescent capacity: $= H \times (P + Z \times 1.5)$

$H = 24\text{Hrs}; P = 0.12\text{A}; Z = 0.136\text{A}$

Therefore, the quiescent capacity is: $= 24 \times (0.12 + 0.136 \times 1.5)$
 $= 7.776\text{Ah}$

Total Battery Capacity: $= 1.25 \times (0.595 + 7.776)$
 $= \underline{10.464\text{Ah}}$

Appendix 6 – ZFP Technical Specification

	STANDARD CABINET	MEDIUM CABINET	LARGE CABINET
Power Supply and Charger			
Mains supply operating voltage	230Vac ±10%, 50/60Hz	230Vac ±10%, 50/60Hz	230Vac ±10%, 50/60Hz
Rated current	1.35A max.	1.35A max.	1.35A max.
Power	310VA	310VA	310VA
Max. continuous output current (including charging)	5A	5A	5A
Battery charge capacity (C)	7Ah min. to 18Ah max.	7Ah min. to 38Ah max.	7Ah min. to 38Ah max.
Max. VRLA battery size	2 x 12V, 18Ah	2 x 12V, 38Ah	2 x 12V, 38Ah
Power rating	Imax a = 4A Imax b = 5A Imin = 12mA	Imax a = 4A Imax b = 5A Imin = 12mA	Imax a = 4A Imax b = 5A Imin = 12mA
Max. internal battery resistance (Ri max.)	600mohm	600mohm	600mohm
Max. output voltage (Mains on)	Vmax = 30V	Vmax = 30V	Vmax = 30V
Min. output voltage (Mains off)	Vmin = 19.2V	Vmin = 19.2V	Vmin = 19.2V
Output ripple voltage (peak-to-peak)	450mV@30MHz bandwidth, 350mV with 100nF loading	450mV@30MHz bandwidth, 350mV with 100nF loading	450mV@30MHz bandwidth, 350mV with 100nF loading
Mains supply/battery charger monitored for failure	√ Yes	√ Yes	√ Yes
Batteries monitored for disconnection and failure	√ Yes	√ Yes	√ Yes
Earth fault monitoring	√ Yes	√ Yes	√ Yes
Loop Driver Specification (programmable & monitored)			
Number of loops	1 to 4	1 to 8	1 to 8
Connector block type	Plug-on type, largest acceptable cable size 2.5mm ²		
Loop driver PCB type	Main 1-Loop PCB, Main 2-Loop PCB, 2-Loop PCB		
Max. output current per loop	500mA (Voltage: 25V min.; 34V max.)		
Communication Protocols	Apollo's XP95 / Discovery		
Max. number of addressable devices	126 per loop (maximum of 512 detectors / call points per panel)		
Type of cable / Max. cable length per loop	Fire resistant screened cable, min. size 1mm ² / 1km max. length		
Max. allowable loop impedance (each conductor)	20 ohm		
Max. cable capacitance	.27µF		
Auto-polling from each loop end	√ Yes		
Line monitored for o/c and s/c faults	√ Yes		
Conventional Sounder Circuits (programmable & monitored)			
Number of circuits	2 x 1A outputs. Protected by resettable overload circuit.		
Connector block type	Plug-on type, largest acceptable cable size 2.5mm ²		
EOL resistor (supplied)	6800 ohm, 5% tolerance, 0.25W		
Output voltage	19.5V min.; 28V max.		
Type of cable / Max. cable length per circuit	Fire resistant screened cable, min. size 1mm ² / 1km max. length		
Line monitored for o/c and s/c faults	√ Yes		
Auxiliary Inputs (programmable & monitored)			
Number of auxiliary inputs	2 (Connect to 0V to trigger, Max. input voltage 27Vdc non-latching)		
EOL resistor value (supplied)	6800 ohm, 5% tolerance, 0.25W		
Trigger resistor (supplied)	470R, 0.25W		
Line monitored for o/c and s/c faults	√ Yes		
Relay Outputs (programmable)			
Number of relay outputs	2 x programmable auxiliary relays; 1 x failsafe fault relay; 1 x 24Vdc auxiliary power output		
Relay type	Volt-free, single pole changeover		
Relay output	1A, 30Vdc (max.)		
Fault relay	Active when faults are present or on total power failure		
24Vdc auxiliary power output	19.5V minimum, 28V maximum. Max. current 100mA.		
Fuses (compliant to IEC EN60127 Pt2)			
Primary fuse (F1)	2A, T, HRC, 20mm ceramic (T=Timed Delay, HRC= High Rupture Current <equivalent> HBC=High Breaking Capacity)		
Battery fuse (F2)	5A, F, HRC, 20mm ceramic (F = Fast Acting)		
Network Specification			
'Hi-NET' multipath network	See Section 6 for a summary of features		
Communication Buses			
Pager (ESPA protocol) / DECT telephone system / Graphics Interface	1 x RS232 connector		
Graphics Interface / Diagnostics	1 x RS485 connector		
Peripheral Bus (A-Bus)	1 x RS485 connector. Allows the connection of A-Bus PCBs (15 max. per panel)		
Networking	RS485 Hi-Integrity, fault-tolerant network		
PC interface	Galvanically isolated USB connector (provided on the Z41 Control/Display module)		
A-Bus PCBs			
A-Bus peripheral PCBs	See Section 7 for a summary of features		
Indicators and Controls			
Standard provision	All models include a Z41 Control/Display Module which comprises a full colour 4.3 inch touchscreen, all mandatory EN 54 indicators, 3 spare LEDs and a keyswitch allowing direct access to AL2.		
Display	LCD Touchscreen, 4.3 inch, 480 x 272 pixel, 24 bit, 16M RGB colour.		
Zonal indicators	Up to 200 separate programmable LEDs available via Switch & Indicator expansion modules.		
Switches & onboard printers	Multiple switch and printer configurations available via Switch & Indicator expansion modules.		
Switch & Indicator module capacity (one of these must be a Z41 Control/Display module)	2	4	6

ZFP Networkable Analogue Addressable Fire Alarm Panel

	STANDARD CABINET	MEDIUM CABINET	LARGE CABINET
ZFP Modules			
Control / Switch & Indicator / Printer Modules	Control/Display module c/w LCD, touchscreen, keyswitch, 16 LEDs. 20 zone indicator module c/w name slots. 20 zone indicator module c/w name slots, 5 switches, 10 LEDs. 20 zone indicator module c/w name slots, printer, 2 switches, 4 LEDs. 40 zone indicator module c/w name slots. 40 zone indicator module c/w 5 switches, 10 LEDs. 40 zone indicator module c/w printer, 2 switches, 4 LEDs 100 zone indicator module, numbered 1-100. 100 zone indicator module, numbered 101-200. Printer module. Blank module.	Part No. Z41. Part No. Z44. Part No. Z45. Part No. Z46. Part No. Z47. Part No. Z48. Part No. Z49. Part No. Z50 / 1-100. Part No. Z50 / 101-200. Part No. Z51. Part No. ZBLANK.	
Mechanical			
Dimensions (lid & back box) H x W x D mm	462 x 450 x 127	720 x 450 x 200	960 x 450 x 200
Fixing Centres (back box) H x W mm	4 holes at 307 x 370	4 holes at 565 x 370	4 holes at 805 x 370
Enclosure material (lid & back box)	Mild steel / zintec 1.2mm thick		
IP Rating (to EN 60529)	IP30		
Case Colours			
Paint finish	Light grey texture (RAL7035) epoxy paint		
Environmental			
Operating Temperature	-5°C to +40°C		
Humidity	5% to 95 % R.H non-condensing		
Standards Compliance			
Compliant with	EN 54 Parts 2 and 4		

Appendix 7 – Glossary of Terms

Addressable System: A fire alarm and detection system that contains addressable control devices.

AL1: Access Level 1 (for general users).

AL2: Access Level 2 (for authorised users).

AL3: Access Level 3 (for authorised systems engineers).

BS 5839-1: Fire detection and alarm systems for buildings: Code of practice for system design, installation and maintenance.

BS 7671: IEE Wiring Regulations.

BS EN 54-2: Fire Detection and Fire Alarm Systems. Control and Indicating Equipment.

BS EN 54-4: Fire Detection and Fire Alarm Systems. Power Supply Equipment.

Compact Controller: A fire alarm control panel with no field device loops connected that can be used to control certain functions of the system. A Compact Controller is a node when connected as part of a network.

DST: Daylight Saving Time.

EOL: end-of-line resistor, value 6k8, ½ watt.

Input Device: Any device that can signal an event such as ‘fire’, ‘fault’, etc. to the fire alarm and detection system, e.g. fire detectors, manual call points, I/O units.

Input Group: Comprise of grouped input devices and used in the C&E programming (max. 1000).

Input Supergroups: Comprise of selected Input Groups and used in the C&E programming (max. 32).

I/O: Input/Output (device) - device that is connected to a fire alarm and detection system and is used to receive and/or transmit information within the system.

LCD: Liquid Crystal Display

Network: A ‘Hi-NET’ multipath network arranged as a loop so that a single fault does not prevent the system from working. A network has a maximum number of 126 nodes.

N/C: Normally closed (relay contact).

N/O: Normally open (relay contact).

Node: Adding a ‘Hi-NET’ network PCB to a panel allows it to become a network node. Compact Controllers include a network PCB fitted as standard.

Output Device: Any device that can act on a command from the fire alarm and detection system, e.g. sounder, beacon, relay, etc.

Output Group: Comprise of grouped output devices and used in C&E programming (max. 1000).

Output Supergroups: Comprise of selected Output Groups and used in C&E programming (max. 32).

Panel: A fire alarm control panel with 2, 4, 6 or 8 field device loops connected to it that can be used to configure a fire alarm and detection system. A panel is a node when connected as part of a network.

PCB: Printed Circuit Board

PSU: Power Supply Unit; that portion of the panel which supplies all voltages necessary for its operation.

SD: Secure Digital (memory card). A non-volatile micro memory card, fitted internally at CONN1 on the Control/Display Module PCB.

Supervisory: Non-fire related action, e.g. open a door, start a fan, etc.

System Devices: Include panel sounder, panel relay, panel keyswitch, panel touchscreen, etc.

Zones: Geographical location of a device (max. 200 zones per panel).

