



DESIGN WALLMOUNT-SPEAKER, PLASTIC

PBC6T/EN



The PBC6T/EN is a wall-mounted speaker that through. Its innovative design looks stylish and elegant.

The high quality reproduction of speech and background music distinguishes this series even further. The effortless and easy installation via a concealed attachment.

Areas of application represent premises in which value is attached design and excellent sound quality is laid, such, bars, restaurants, hotels, reception rooms, prestigious rooms, medical office waiting rooms, offices, etc.



EN54-24:2008 0359-CPD-0151 TYPE A

● Standard	Compliant to EN54-24 Compliant to BS5839:8
● Electrical	
Rated power, Watts	6
Tappings 100 Volt line, Watts	6/3/1.5/0.75/0.25
Transformer Impedance, Ohms 100 Volt	1.67k/3.33k/6.66k/13.3k/40k
Tappings 70.7 Volt line, Watts	3/1.5/0.75/0.375/0.125
Driver impedance, Ohms	8
Effective Frequency Range, Hz (BSEN60268-5)	160-18.000
S.P.L. @ 1 m, 1 Watt, dB, Octave, 100 Hz-10 kHz	95
S.P.L. @ 1 m, Full power, dB, Octave, 100 Hz-10 kHz	102
S.P.L. @ 4 m, 1 Watt, dB, 1/3 Octave, 100 Hz-10 kHz	81
S.P.L. @ 4 m, Full power, dB, 1/3 Octave, 100 Hz-10 kHz	87
Dispersion at 1k/2k Hz, Degrees	119/100 Horizontal 77/99 Vertical
● Environmental	
IP Rating	21
Min/Max amb temp	-10°C to 55°C
Relative Humidity	≤95%
● Mechanical	
Dimensions, WxHxD mm	330 x 240 x 90
Net weight, kg	1.15
Colour (Unless Specified)	White, RAL9016
Material	Low smoke zero Halogen UL-94V0 Plastic with UV inhibitors
Mounting	Keyhole and/or screws
Safety	Ceramic Block Thermal Fuse



ATEIS Europe B.V.
Celsiusstraat 1, 2652 XN Lansingerland, Netherlands
Phone +31 (0)10 208 86 90, www.ateis-europe.com, info@ateis-europe.com





PENTON

INSTALLATION GUIDE

PBC6T/EN

EN54-24:2008
0359-CPD-0151
TYPE A

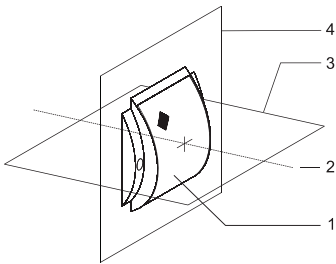
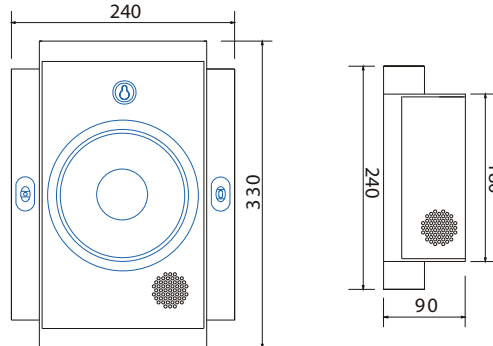

1. Loudspeaker enclosure
2. Reference axis
3. Horizontal plane
4. Reference plane

With Transformer:
100V/70V line

	White wire plus tapping						Black
100V	0.25W	0.75W	1.5W	3W	6W	COM	
70V	0.125W	0.375W	0.75W	1.5W	3W	COM	
IMP (Ω)	39.9k	13.3k	6.66k	3.33k	1.67k		

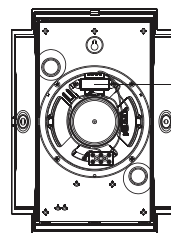
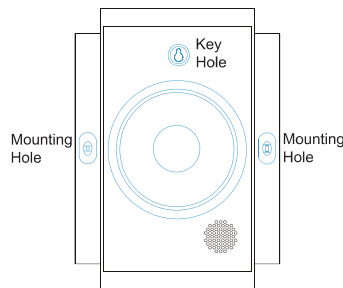
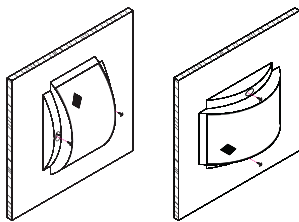

3) Connect the speaker cable into the 3 way terminal block located on the cabinet. Select your required tapping by moving the white lead to your chosen tapping on the transformer. All tapings are marked on top of the transformer.

1) Decide on the speaker orientation and place the speaker on a flat surface. It can be installed in any orientation as well as horizontally on a ceiling if required. Mark through the mounting holes in order to position the fixing points which will be 210mm apart. A "Picture Hook" type mounting is also provided which is located at the top section of the speaker. See drawing marked "Key Hole". Prepare the surface to take suitable fixings (Not included).

2) If 20mm cable glands are to be used then the speaker cabinet can be drilled using a suitable drill bit. Make sure you place the cable entry in a location that will not cause the cable to be blocked or restricted by any internal components. If you are not using cable glands the back of the speaker cabinet has 2 x "knock out" tabs in the top and side which when removed will allow the speaker cable to pass between the speaker and mounting surface.

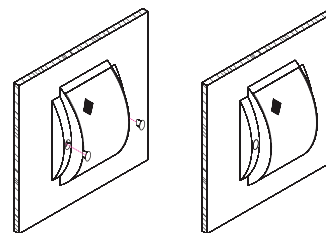

4) Fix the speaker cabinet to the wall using suitable fixings (not provided).
5) Fit the 2 x removable covers over the fixing holes.

Frequency response

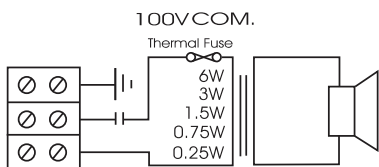

Circuit Diagram

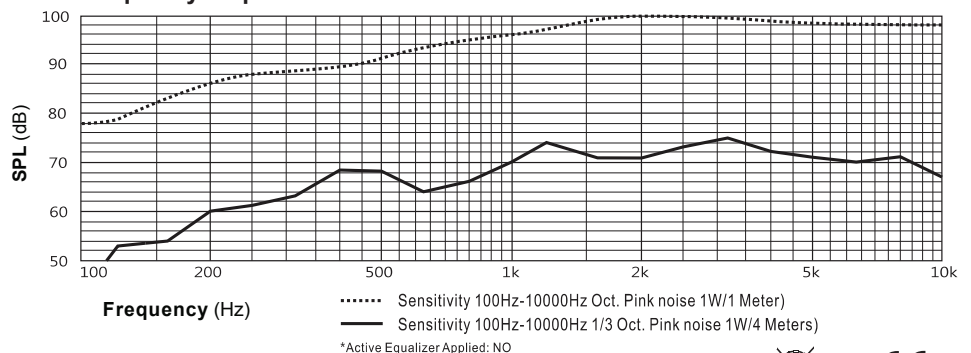

Disclaimer: We reserve the right of changes and errors.



ATEIS Europe B.V.
Celsiusstraat 1, 2652 XN Lansingerland, Netherlands
Phone +31 (0)10 208 86 90, www.ateis-europe.com, info@ateis-europe.com

