

WA-225W

Wi-Fi STEREO AMPLIFIER

INSTRUCTION MANUAL



FONESTAR

We take this opportunity to thank you for buying this product.

We recommend you read the instruction manual before switching on the machine and follow the instructions that are given. Keep the manual for future reference.

SECURITY AND THE ENVIRONMENT

ELECTRICAL SECURITY

Check that the current in the mains connection where the machine is to be installed corresponds to the power supply of the machine.

To avoid damaging the equipment, electrical shocks, fire or physical injury when you connect or disconnect the equipment from the power supply, pull the plug firmly out of the mains socket holding the plug, never the cable.

Always do this with dry hands.

Keep the power supply cable far from sources of heat. Do not put heavy objects on top of it or change it.

Clean dust and dirt off the power supply cable regularly.

Do not open the machine; you could get an electric shock.

CAUTION

While installing the machine, make sure it is switched off and unplugged.

Do not open the machine. Touching the internal parts is dangerous and you could receive an electric shock.

The machine must not be splashed or dripped on. Never place recipients with liquid inside on the machine.

Do not place anything inside the machine.

LOCATION

Place the equipment on a horizontal surface with enough space around it to allow ventilation.

Avoid direct sunlight, heat sources and excessive dust.

Do not place the machine near magnetic fields or static electricity.

Do not use surfaces which vibrate or receive impact.

Do not pile machines on top of one another.

VENTILATION

Never block or cover the ventilation slits on the machine.

Do not expose it to direct sunlight or place it near sources of heat.

PERIODS OF INACTIVITY

When the machine is not going to be used for a long period of time, disconnect it from the mains.

If you are using an adapter, take into account that it will continue using electricity even if the machine is switched off. If it is not going to be used for a long period of time, disconnect it from the mains.

THE ENVIRONMENT

To save energy, switch the machine off when you are not going to use it for a long time. The machine could contain substances that are harmful to the environment or human health. To minimize the effect of these substances the machine must be correctly managed and recycled when you decide to dispose of it.

When you dispose of it remember: it cannot be thrown into a conventional rubbish bin.

If it contains or uses batteries, these must be disposed of separately.

The machine (without batteries) must be disposed of correctly. Put it in a container specially intended for the collection of electronic and electrical appliances, at the dump or hand it over to the dealer when you purchase similar equipment, so that the dealer can dispose of it correctly (at no added cost).

SIGNIFICANCE OF THE SYMBOLS ON THE MACHINE*



The symbol formed by the expression “Class 1 laser product” written in a rectangle indicates that visible or invisible laser radiation could be produced. Avoid direct expose to the laser.



The symbol formed by a ray of lightening inside a triangle shows that the machine has connection terminals or a circuit with areas with a current which could cause an electric shock, even in normal working conditions.



The symbol formed by an exclamation mark in a triangle shows that the instruction manual must be referred to for information on how the machine works and its use.



The symbol formed by one square inside another square shows that the machine has double electrical insulation.



The European Community symbol shows that the machine complies with the current European Union legislation, as well as its transposition to local legislation.



The symbol of a rubbish bin crossed out and over a horizontal line shows that when the product is disposed of it must be done properly, placing it in a special selective electronic and electrical equipment container or through a dealer when purchasing a similar product, at no additional cost. It also shows that the machine was put on the market after 13th August 2005 (European Community Directive 2002/96/CE of Electrical and Electronic recycling, and its Spanish equivalent R.D.208/2005).

In accordance with what is set out in the aforementioned decree, FONESTAR is registered in the RAEE (Registro de Aparatos Eléctricos y Electrónicos) in a special section REI (Registro de establecimientos Industriales), with the entry number 001851.

*It is possible that some of these symbols do not appear on the machine.

EXEMPTION OF LIABILITY

The characteristics of the equipment and the content of the manual can change without forewarning.

FONESTAR, S.A. does not assume responsibilities regarding the inappropriate use of the equipment or the information supplied in this instruction manual, and specifically disclaims any implied liability for marketability or fitness for any other use.

All rights reserved by **FONESTAR, S.A.**

DESCRIPTION

- Wi-Fi stereo amplifier. 2 x 20 W RMS at 4 Ω.
- Multiroom audio system which allows several amplifiers to be controlled and different music programs to be played: playlists, online music services and internet radio. Playback via Wi-Fi, USB player and aux input.
- App to control from smartphones and tablets.
- Compact construction for installation. Class D highly efficient amplification circuit.

CONTROLS AND FUNCTIONS

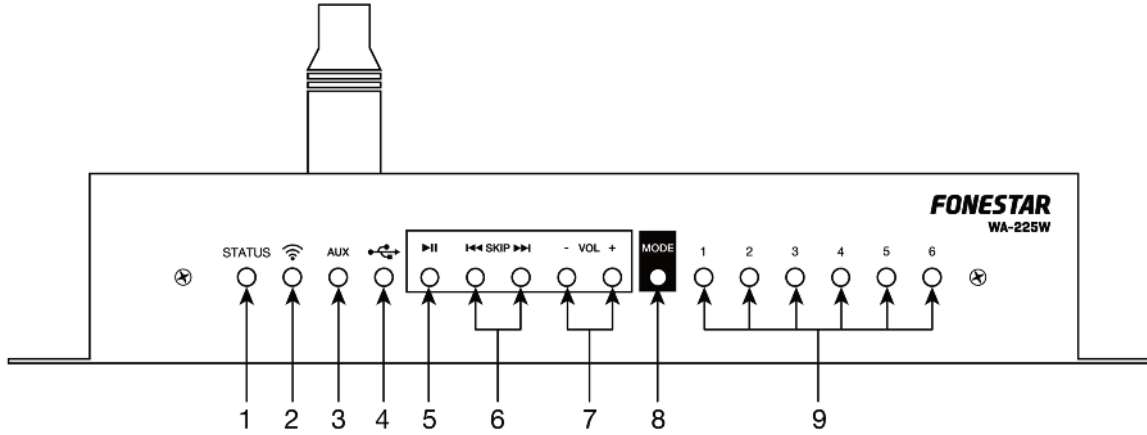

- 1.- **STATUS:** LED status indicator.
It flashes slowly when the amplifier is searching for a network or waiting to be connected to a wireless network.
It flashes quickly when the amplifier is connected to the network.
It remains permanently lit in red when the device is connected to the network and ready to operate.
- 2.- LED Wi-Fi operating mode indicator.
- 3.- **AUX:** LED aux input operating mode indicator.
- 4.- LED USB operating mode indicator.
- 5.- **▶||:** starts and pauses playback.
- 6.- **◀▶:** buttons which allow moving to the previous/next track to the one currently being played.
- 7.- **VOL -/+:** volume controls.
- 8.- **MODE:** button which allows the playback mode to be changed among: playback in Wi-Fi mode, aux input and USB storage device connected to the amplifier.
- 9.- Direct access to the presets 1-6. In order to establish which station you wish to store in each preset position, the APP MÜZO must be used.

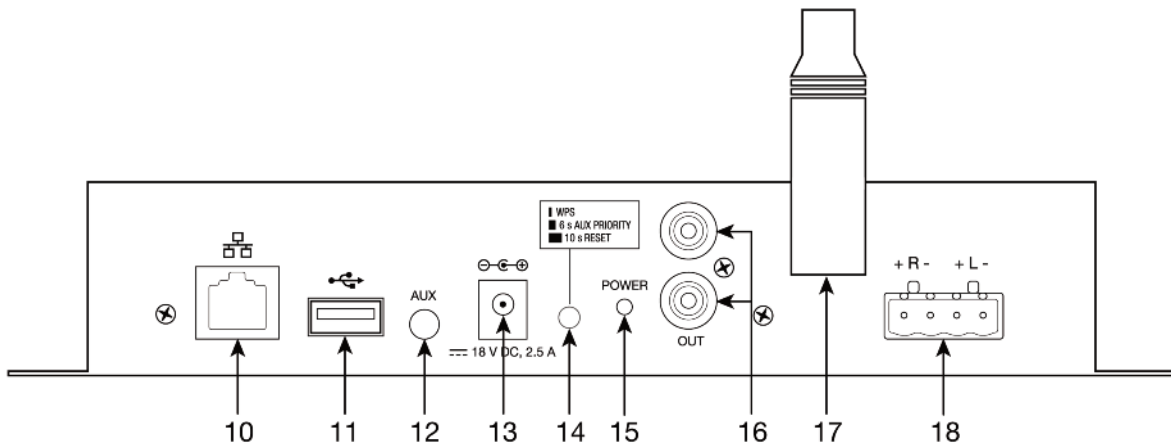

10. Ethernet input to connect the amplifier to a router, RJ-45 connector. Allows the device to be connected by cable to a router for its subsequent use via the application.
11. USB storage device connection port. Allows playback of audio files contained in MP3 format.
12. **AUX**: aux input, 3.5 mm jack connector. This input has priority through signal level.
Note: by default, priority is deactivated. In order to activate the priority function in this input, press and hold the button for 6 seconds. (14).
13. Power supply input for mains adapter provided.
14. Wi-Fi Protected Setup (WPS) button. It has several operating modes:
 - 1) Short press: WPS function, allows the device to be connected wirelessly to the existing network and therefore operate correctly. The WPS button must be pressed when the **WA-225W** amplifier is first connected to the network. This connection is made using the APP **MÜZO** which informs you of when to press the button.
 - 2) 6-second press: to activate/deactivate the priority through signal level function in this input. Priority is deactivated by default.
 - 3) 10-second press: to reset factory values.
15. **POWER**: amplifier LED power indicator.
16. **OUT**: line level aux output, 2 x RCA connectors.
- 17- Antenna to improve wireless reception.
18. Stereo loudspeaker output, euroblock connectors. Connect low impedance loudspeakers (4-8 Ω).
The amplifier is low impedance, so the loudspeakers must be connected in a series/parallel circuit so that the impedance load of the loudspeakers is equal to the amplifier output impedance and that the power supplied by the amplifier does not exceed that withstood by the loudspeakers: 20 + 20 W RMS at 4 Ω .

OPERATING WITH ETHERNET CABLE

- The amplifier can operate using ethernet cable, instead of wirelessly. To do so, connect the amplifier to a router using the input indicated below:

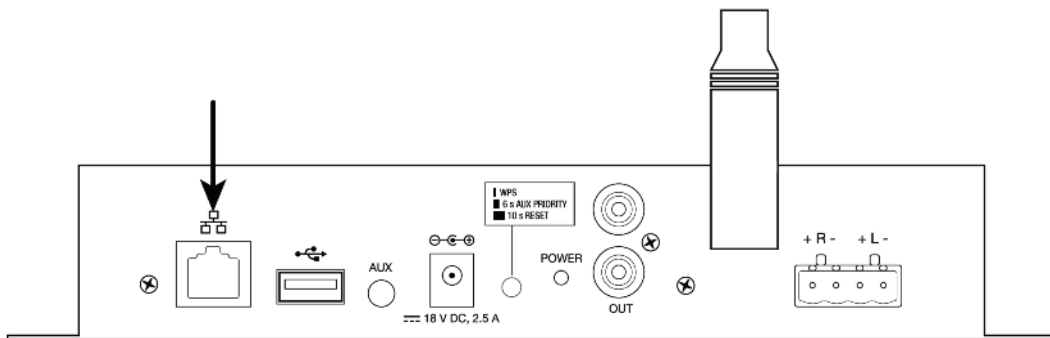

- To operate, use the **MÜZO** application to configure each amplifier in the installation.

Wi-Fi OPERATING

- In order to remotely control and fully benefit from the functions of this amplifier, the free **MÜZO** application can be used. It is available for downloading in the PlayStore for Android or in AppleStore for iOS. Using this application, you will be able to connect the device to the Wi-Fi network, change the mode, increase/reduce the volume as well as configure and control the radio stations; all this in one or several **WA-225W** amplifiers.
- Firstly, download and install the APP and follow the steps for connecting the amplifier to a Wi-Fi network. Once connected, you will have access to all the functions from your mobile device.

- The following images give us a quick idea of the simplicity of the application.
- In figure 2, we have several amplifiers added to our web and from here we select one or another in order to control.
- In figure 3, we have the menu from which we select the audio source, the most frequent are: “My music” to play music from our telephone or from a USB connected to the amplifier, “TuneIn” for online radio stations, “Spotify” to play music from the Spotify APP (Premium account required) and “Line input” for the devices connected to the AUX input of the **WA-225W**.
- Figure 4 displays a list of radio stations stored in the memory. These stations can be activated directly from the front of the amplifier using the number buttons 1 - 6.

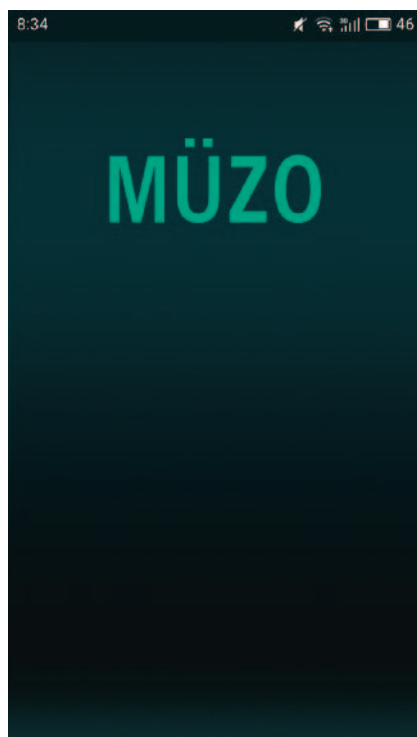

Fig.1

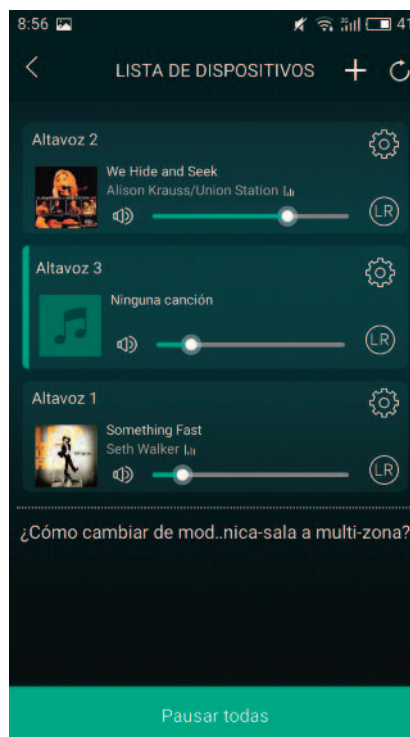

Fig.2

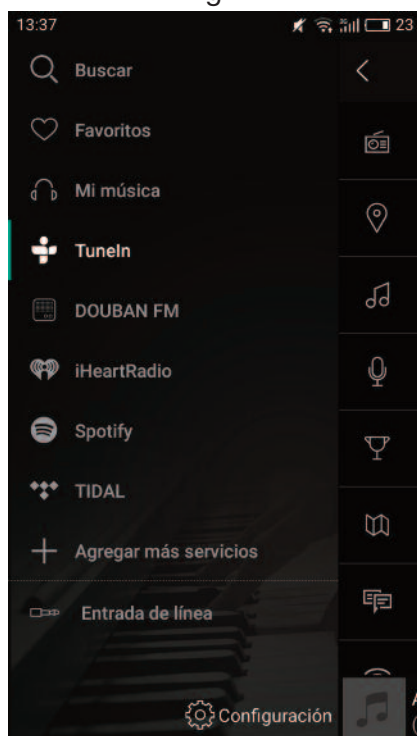
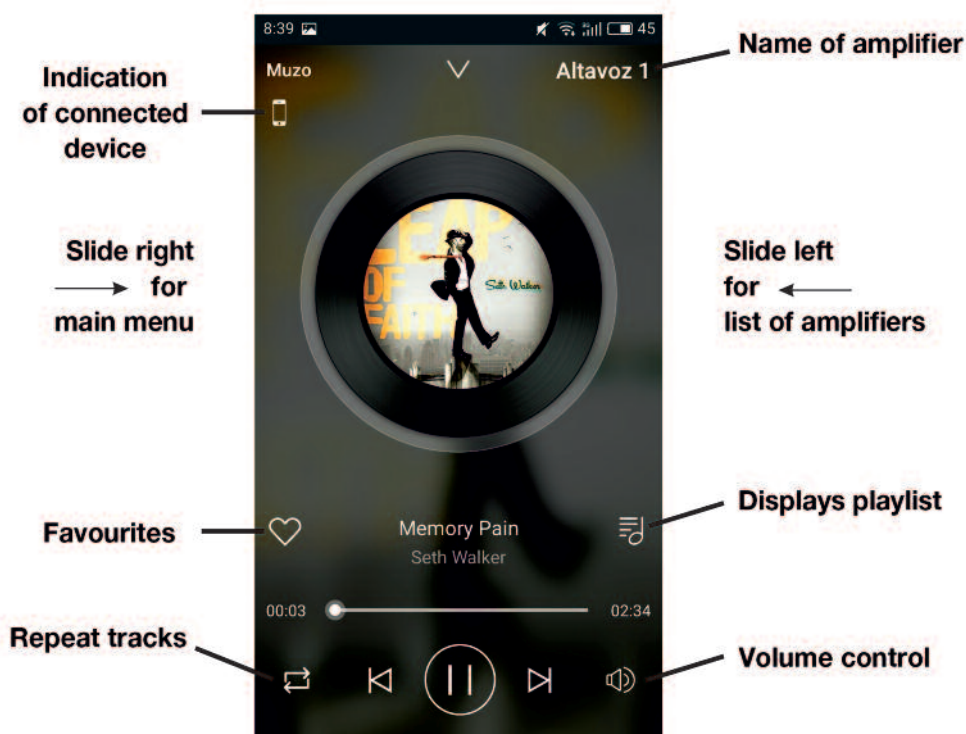

Fig.3



Fig.4

- Finally, once the device is playing, the following screen will be displayed. Below, we explain the useful information to be found.



TECHNICAL SPECIFICATIONS

	WA-225W
CHARACTERISTICS	Wi-Fi stereo amplifier. Multiroom audio system. App to control from smartphones and tablets. Playlist, online music services and internet radio playback via Wi-Fi. 6 customizable preset buttons. USB player and aux input. Steel box for surface assembly. Stereo loudspeaker output.
POWER	2 x 20 W RMS at 4 Ω
RESPONSE	20-17,000 Hz -3 dB
DISTORTION	Harmonic: < 0.04% at 1 kHz
INPUTS	1 aux, 3.5 mm jack 7,700 Ω 1 V 1 RJ-45 Ethernet
OUTPUTS	Loudspeakers: 4-8 Ω, euroblock 1 aux, 2 x RCA
CONTROLS	Playback control and 6 customizable preset buttons
S/N RATIO	≤ 80 dB
POWER SUPPLY	18 V DC, 2.5 A with adapter included
DIMENSIONS	227 x 38 x 100 mm depth

DECLARATION OF CONFORMITY



FONESTAR SISTEMAS S.A.

Polígono de Trascueto s/n
39600 Revilla de Camargo, Cantabria (Spain)

Declares, under its responsibility, that the following device:

Description: Wi-Fi stereo amplifier
Brand: FONESTAR
Model: WA-225W

complies with that shown in the European Parliament and Council directive RED 2014/53/UE of 16th April 2014.

This is class 1 equipment and has no use restrictions.

List of standards applied

Standard	Area	Compliance with the 214/53/EU essential directive requirements
EN 300 328: V1.9.1	RADIO	Section 3.2 2014/53/EU directive
EN 301 489-17: V2.2.1	EMC	Section 3.1b 2014/53/EU directive
EN 301 489-1: V1.9.2		
EN 60065:2014	ELECTRICAL SAFETY	Section 3.1a 2014/35/EU directive
EN 62311:2008		

Santander, 9th June, 2017

Juan Vallejo
Technical Engineer, Sales Department

WARRANTY

This product has been tested and has passed the corresponding quality control prior to being put on the market.

FONESTAR guarantees the suitability of the product for its specified use during a period of 2 years from the delivery date and commits itself to repair or substitute the goods as expressed in the Spanish law 'La Ley General para la Defensa de los Consumidores y Usuarios, Real Decreto Legislativo 1/2007 16 Noviembre.

The lack of conformity in the first six months after purchase, due to a manufacturing defect, will be rectified with no more than showing the proof of purchase. After six months **FONESTAR** reserves the right to demand proof of the product being sold with that problem.

This warranty does not include damage produced by: inappropriate use or negligence, accidents, worn out parts due to use, breakages, burns, spilt liquids or other substances, excessive humidity, battery deterioration and internal manipulation of the device, the software or its components by unauthorized persons, and in general any use that is unrelated to the nature and purpose of the product.

If any service is needed during the warranty period because of lack of conformity, please contact the business or distributor where the product was purchased in no more than 2 months after being conscious of the problem. It is only necessary to contact **FONESTAR** if it is impossible or imposes an undue burden for them to solve it. To benefit from this warranty it is necessary to show the proof of purchase with the date clearly visible, with no corrections or crossing out.

This document adds information, and never decreases the consumers' rights, which in all cases are protected by the Spanish law 'La Ley General para la Defensa de los Consumidores y Usuarios, Real Decreto Legislativo 1/2007 16 Noviembre'.



FONESTAR is a member of ECOEMBALAJES ESPAÑA, S.A. "ECOEMBES", with number 03497 and all our products carry the symbol, backed by our membership and subscription to the above mentioned organization with the recycling and subsequent management of our packaging.

FONESTAR, S.A. - NIF A28780443 - Polígono Trascueto - 39600 Revilla de Camargo, Cantabria (Spain)

www.fonestar.com